

定位扣件 · 自行鎖附 - 帶有標準手柄

EH 22370. /EH 22380.



產品描述

為了快速緊固，鎖定，調整，變換和維安。快速輕鬆地解開了頻繁重複性的連接。全系列都是抗腐蝕的。不銹鋼1.4542：高強度，硬化，高耐磨性與高鶴重銷子。精巧設計凹陷與抓地力。

材質

- 梢子零件
- 不銹鋼 1.4305
 - 不銹鋼 1.4542，沉澱硬化

彈簧

- 不銹鋼

操作

按下按鈕即可解鎖球。

特性

不銹鋼 1.4542 在鋼珠下有記號

更多資訊

注意事項

特殊的樣式歡迎洽詢。

配件

可以與 EH 22400. 配合使用。

更多產品

- 定位扣件，自鎖，帶標準手柄，鈦合金
- 定位襯套，用單邊作動 ball lock 梢
- 定位襯套，帶有法蘭，用於球鎖定銷和座銷
- 保持纜
- 定位襯套，帶有軸環，DIN 172 A
- 定位襯套，無軸環，DIN 179 A

圖面

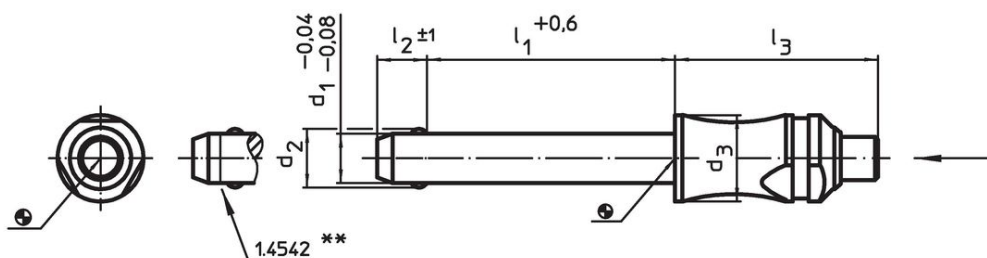



不銹鋼1.4542設計，具有標識記號



訂單資訊

d ₁ -0,04 -0,08	l ₁ +0,6	尺寸				定位孔 H11 [mm]	max. [°C]	[g]	剪力抵抗力，加倍的 ¹⁾ min [kN]	品號
		d ₂	d ₃	l ₂ ±1	l ₃					
不銹鋼 1.4305										
5	10	5,5	10	6,0	26,2	5	250	10	14	22370.0012
5	15	5,5	10	6,0	26,2	5	250	11	14	22370.0013
5	20	5,5	10	6,0	26,2	5	250	12	14	22370.0014
5	25	5,5	10	6,0	26,2	5	250	12	14	22370.0015
5	30	5,5	10	6,0	26,2	5	250	13	14	22370.0016
5	35	5,5	10	6,0	26,2	5	250	14	14	22370.0017
5	40	5,5	10	6,0	26,2	5	250	14	14	22370.0018
5	45	5,5	10	6,0	26,2	5	250	15	14	22370.0007
5	50	5,5	10	6,0	26,2	5	250	16	14	22370.0008
5	60	5,5	10	6,0	26,2	5	250	17	14	22370.0009
5	70	5,5	10	6,0	26,2	5	250	19	14	22370.0010
5	80	5,5	10	6,0	26,2	5	250	20	14	22370.0011
6	10	7,0	10	7,0	26,2	6	250	11	21	22370.0022
6	15	7,0	10	7,0	26,2	6	250	12	21	22370.0023



¹⁾ 抗剪力類似 DIN 50141

d ₁ -0,04 -0,08	l ₁ +0,6	尺寸				l ₂ ±1	l ₃	定位孔 H11	 max.	 [g]	剪力抵抗 力, 加倍的 ¹⁾ min	品號
		d ₂	d ₃	[mm]								
6	20	7,0	10	7,0	26,2	6	250	13	21	22370.0024		
6	25	7,0	10	7,0	26,2	6	250	14	21	22370.0025		
6	30	7,0	10	7,0	26,2	6	250	15	21	22370.0026		
6	35	7,0	10	7,0	26,2	6	250	16	21	22370.0027		
6	40	7,0	10	7,0	26,2	6	250	17	21	22370.0028		
6	45	7,0	10	7,0	26,2	6	250	18	21	22370.0029		
6	50	7,0	10	7,0	26,2	6	250	19	21	22370.0030		
6	60	7,0	10	7,0	26,2	6	250	21	21	22370.0019		
6	70	7,0	10	7,0	26,2	6	250	23	21	22370.0020		
6	80	7,0	10	7,0	26,2	6	250	25	21	22370.0021		
8	10	9,5	14	8,2	33,1	8	250	29	38	22370.0032		
8	15	9,5	14	8,2	33,1	8	250	31	38	22370.0033		
8	20	9,5	14	8,2	33,1	8	250	32	38	22370.0034		
8	25	9,5	14	8,2	33,1	8	250	34	38	22370.0035		
8	30	9,5	14	8,2	33,1	8	250	36	38	22370.0036		
8	35	9,5	14	8,2	33,1	8	250	38	38	22370.0037		
8	40	9,5	14	8,2	33,1	8	250	40	38	22370.0038		
8	45	9,5	14	8,2	33,1	8	250	42	38	22370.0039		
8	50	9,5	14	8,2	33,1	8	250	44	38	22370.0040		
8	60	9,5	14	8,2	33,1	8	250	47	38	22370.0031		
8	70	9,5	14	8,2	33,1	8	250	51	38	22370.0041		
8	80	9,5	14	8,2	33,1	8	250	54	38	22370.0042		
8	90	9,5	14	8,2	33,1	8	250	58	38	22370.0043		
8	100	9,5	14	8,2	33,1	8	250	62	38	22370.0051		
10	15	12,0	14	9,6	33,1	10	250	36	60	22370.0059		
10	20	12,0	14	9,6	33,1	10	250	39	60	22370.0044		
10	25	12,0	14	9,6	33,1	10	250	42	60	22370.0045		
10	30	12,0	14	9,6	33,1	10	250	45	60	22370.0046		
10	35	12,0	14	9,6	33,1	10	250	48	60	22370.0047		
10	40	12,0	14	9,6	33,1	10	250	51	60	22370.0048		
10	45	12,0	14	9,6	33,1	10	250	54	60	22370.0049		
10	50	12,0	14	9,6	33,1	10	250	57	60	22370.0050		
10	60	12,0	14	9,6	33,1	10	250	63	60	22370.0052		
10	70	12,0	14	9,6	33,1	10	250	69	60	22370.0053		
10	80	12,0	14	9,6	33,1	10	250	74	60	22370.0054		
10	90	12,0	14	9,6	33,1	10	250	80	60	22370.0055		
10	100	12,0	14	9,6	33,1	10	250	86	60	22370.0056		
10	110	12,0	14	9,6	33,1	10	250	92	60	22370.0057		
10	120	12,0	14	9,6	33,1	10	250	98	60	22370.0058		
12	20	14,5	20	10,6	39,5	12	250	79	87	22370.0064		
12	25	14,5	20	10,6	39,5	12	250	84	87	22370.0065		
12	30	14,5	20	10,6	39,5	12	250	88	87	22370.0066		
12	35	14,5	20	10,6	39,5	12	250	92	87	22370.0067		
12	40	14,5	20	10,6	39,5	12	250	97	87	22370.0068		
12	45	14,5	20	10,6	39,5	12	250	101	87	22370.0069		
12	50	14,5	20	10,6	39,5	12	250	105	87	22370.0070		
12	60	14,5	20	10,6	39,5	12	250	113	87	22370.0072		
12	70	14,5	20	10,6	39,5	12	250	122	87	22370.0074		
12	80	14,5	20	10,6	39,5	12	250	130	87	22370.0076		
12	90	14,5	20	10,6	39,5	12	250	139	87	22370.0060		
12	100	14,5	20	10,6	39,5	12	250	147	87	22370.0061		
12	110	14,5	20	10,6	39,5	12	250	156	87	22370.0062		
12	120	14,5	20	10,6	39,5	12	250	165	87	22370.0063		
16	30	19,0	20	14,0	39,5	16	250	123	155	22370.0086		
16	35	19,0	20	14,0	39,5	16	250	130	155	22370.0087		
16	40	19,0	20	14,0	39,5	16	250	138	155	22370.0088		
16	45	19,0	20	14,0	39,5	16	250	146	155	22370.0089		
16	50	19,0	20	14,0	39,5	16	250	154	155	22370.0090		
16	60	19,0	20	14,0	39,5	16	250	169	155	22370.0092		

¹⁾ 抗剪力類似 DIN 50141

d ₁ -0,04 -0,08	l ₁ +0,6	尺寸				l ₂ ±1	l ₃	定位孔 H11	 max.	 [g]	剪力抵抗 力, 加倍的 ¹⁾ min	品號
		d ₂	d ₃	[mm]								
16	70	19,0	20	14,0	39,5	16	250	185	155	22370.0094		
16	80	19,0	20	14,0	39,5	16	250	200	155	22370.0096		
16	90	19,0	20	14,0	39,5	16	250	216	155	22370.0097		
16	100	19,0	20	14,0	39,5	16	250	232	155	22370.0098		
16	110	19,0	20	14,0	39,5	16	250	248	155	22370.0099		
16	120	19,0	20	14,0	39,5	16	250	263	155	22370.0100		
16	130	19,0	20	14,0	39,5	16	250	278	155	22370.0101		
16	140	19,0	20	14,0	39,5	16	250	294	155	22370.0102		
16	150	19,0	20	14,0	39,5	16	250	310	155	22370.0103		
20	50	25,0	28	20,5	49,9	20	250	301	244	22370.0111		
20	60	25,0	28	20,5	49,9	20	250	326	244	22370.0112		
20	70	25,0	28	20,5	49,9	20	250	351	244	22370.0113		
20	80	25,0	28	20,5	49,9	20	250	375	244	22370.0116		
20	90	25,0	28	20,5	49,9	20	250	399	244	22370.0117		
20	100	25,0	28	20,5	49,9	20	250	423	244	22370.0120		
20	110	25,0	28	20,5	49,9	20	250	448	244	22370.0121		
20	120	25,0	28	20,5	49,9	20	250	472	244	22370.0124		
20	130	25,0	28	20,5	49,9	20	250	498	244	22370.0125		
20	140	25,0	28	20,5	49,9	20	250	520	244	22370.0126		
20	150	25,0	28	20,5	49,9	20	250	546	244	22370.0127		
25	50	30,8	28	22,0	49,9	25	250	399	386	22370.0129		
25	60	30,8	28	22,0	49,9	25	250	437	386	22370.0130		
25	70	30,8	28	22,0	49,9	25	250	477	386	22370.0131		
25	80	30,8	28	22,0	49,9	25	250	513	386	22370.0132		
25	90	30,8	28	22,0	49,9	25	250	551	386	22370.0133		
25	100	30,8	28	22,0	49,9	25	250	588	386	22370.0134		
25	110	30,8	28	22,0	49,9	25	250	627	386	22370.0135		
25	120	30,8	28	22,0	49,9	25	250	664	386	22370.0136		
25	130	30,8	28	22,0	49,9	25	250	703	386	22370.0137		
25	140	30,8	28	22,0	49,9	25	250	743	386	22370.0138		
25	150	30,8	28	22,0	49,9	25	250	779	386	22370.0139		
不鏽鋼 1.4542, 沉澱硬化												
5	10	5,5	10	6,0	26,2	5	250	10	24	22380.0012		
5	15	5,5	10	6,0	26,2	5	250	11	24	22380.0013		
5	20	5,5	10	6,0	26,2	5	250	12	24	22380.0014		
5	25	5,5	10	6,0	26,2	5	250	12	24	22380.0015		
5	30	5,5	10	6,0	26,2	5	250	13	24	22380.0016		
5	35	5,5	10	6,0	26,2	5	250	14	24	22380.0017		
5	40	5,5	10	6,0	26,2	5	250	14	24	22380.0018		
5	45	5,5	10	6,0	26,2	5	250	15	24	22380.0007		
5	50	5,5	10	6,0	26,2	5	250	16	24	22380.0008		
5	60	5,5	10	6,0	26,2	5	250	17	24	22380.0009		
5	70	5,5	10	6,0	26,2	5	250	19	24	22380.0010		
5	80	5,5	10	6,0	26,2	5	250	20	24	22380.0011		
6	10	7,0	10	7,0	26,2	6	250	11	35	22380.0022		
6	15	7,0	10	7,0	26,2	6	250	12	35	22380.0023		
6	20	7,0	10	7,0	26,2	6	250	13	35	22380.0024		
6	25	7,0	10	7,0	26,2	6	250	14	35	22380.0025		
6	30	7,0	10	7,0	26,2	6	250	15	35	22380.0026		
6	35	7,0	10	7,0	26,2	6	250	16	35	22380.0027		
6	40	7,0	10	7,0	26,2	6	250	17	35	22380.0028		
6	45	7,0	10	7,0	26,2	6	250	18	35	22380.0029		
6	50	7,0	10	7,0	26,2	6	250	19	35	22380.0030		
6	60	7,0	10	7,0	26,2	6	250	21	35	22380.0019		
6	70	7,0	10	7,0	26,2	6	250	23	35	22380.0020		
6	80	7,0	10	7,0	26,2	6	250	25	35	22380.0021		
8	10	9,5	14	8,2	33,1	8	250	29	63	22380.0032		
8	15	9,5	14	8,2	33,1	8	250	31	63	22380.0033		

¹⁾ 抗剪力類似 DIN 50141

d ₁ -0,04 -0,08	l ₁ +0,6	尺寸				l ₂ ±1	l ₃	定位孔 H11	 max.	 [g]	剪力抵抗 力, 加倍的 ¹⁾ min	品號
		d ₂	d ₃	[mm]								
8	20	9,5	14	8,2	33,1	8	250	32	63	22380.0034		
8	25	9,5	14	8,2	33,1	8	250	34	63	22380.0035		
8	30	9,5	14	8,2	33,1	8	250	36	63	22380.0036		
8	35	9,5	14	8,2	33,1	8	250	38	63	22380.0037		
8	40	9,5	14	8,2	33,1	8	250	40	63	22380.0038		
8	45	9,5	14	8,2	33,1	8	250	42	63	22380.0039		
8	50	9,5	14	8,2	33,1	8	250	44	63	22380.0040		
8	60	9,5	14	8,2	33,1	8	250	47	63	22380.0031		
8	70	9,5	14	8,2	33,1	8	250	51	63	22380.0041		
8	80	9,5	14	8,2	33,1	8	250	54	63	22380.0042		
8	90	9,5	14	8,2	33,1	8	250	58	63	22380.0043		
8	100	9,5	14	8,2	33,1	8	250	62	63	22380.0051		
10	15	12,0	14	9,6	33,1	10	250	36	100	22380.0059		
10	20	12,0	14	9,6	33,1	10	250	39	100	22380.0044		
10	25	12,0	14	9,6	33,1	10	250	42	100	22380.0045		
10	30	12,0	14	9,6	33,1	10	250	45	100	22380.0046		
10	35	12,0	14	9,6	33,1	10	250	48	100	22380.0047		
10	40	12,0	14	9,6	33,1	10	250	51	100	22380.0048		
10	45	12,0	14	9,6	33,1	10	250	54	100	22380.0049		
10	50	12,0	14	9,6	33,1	10	250	57	100	22380.0050		
10	60	12,0	14	9,6	33,1	10	250	63	100	22380.0052		
10	70	12,0	14	9,6	33,1	10	250	69	100	22380.0053		
10	80	12,0	14	9,6	33,1	10	250	74	100	22380.0054		
10	90	12,0	14	9,6	33,1	10	250	80	100	22380.0055		
10	100	12,0	14	9,6	33,1	10	250	86	100	22380.0056		
10	110	12,0	14	9,6	33,1	10	250	92	100	22380.0057		
10	120	12,0	14	9,6	33,1	10	250	98	100	22380.0058		
12	20	14,5	20	10,6	39,5	12	250	79	144	22380.0064		
12	25	14,5	20	10,6	39,5	12	250	84	144	22380.0065		
12	30	14,5	20	10,6	39,5	12	250	88	144	22380.0066		
12	35	14,5	20	10,6	39,5	12	250	92	144	22380.0067		
12	40	14,5	20	10,6	39,5	12	250	97	144	22380.0068		
12	45	14,5	20	10,6	39,5	12	250	101	144	22380.0069		
12	50	14,5	20	10,6	39,5	12	250	105	144	22380.0070		
12	60	14,5	20	10,6	39,5	12	250	113	144	22380.0072		
12	70	14,5	20	10,6	39,5	12	250	122	144	22380.0074		
12	80	14,5	20	10,6	39,5	12	250	130	144	22380.0076		
12	90	14,5	20	10,6	39,5	12	250	139	144	22380.0060		
12	100	14,5	20	10,6	39,5	12	250	147	144	22380.0061		
12	110	14,5	20	10,6	39,5	12	250	156	144	22380.0062		
12	120	14,5	20	10,6	39,5	12	250	165	144	22380.0063		
16	30	19,0	20	14,0	39,5	16	250	123	257	22380.0086		
16	35	19,0	20	14,0	39,5	16	250	130	257	22380.0087		
16	40	19,0	20	14,0	39,5	16	250	138	257	22380.0088		
16	45	19,0	20	14,0	39,5	16	250	146	257	22380.0089		
16	50	19,0	20	14,0	39,5	16	250	154	257	22380.0090		
16	60	19,0	20	14,0	39,5	16	250	169	257	22380.0092		
16	70	19,0	20	14,0	39,5	16	250	185	257	22380.0094		
16	80	19,0	20	14,0	39,5	16	250	200	257	22380.0096		
16	90	19,0	20	14,0	39,5	16	250	216	257	22380.0097		
16	100	19,0	20	14,0	39,5	16	250	232	257	22380.0098		
16	110	19,0	20	14,0	39,5	16	250	248	257	22380.0099		
16	120	19,0	20	14,0	39,5	16	250	263	257	22380.0100		
16	130	19,0	20	14,0	39,5	16	250	278	257	22380.0101		
16	140	19,0	20	14,0	39,5	16	250	294	257	22380.0102		
16	150	19,0	20	14,0	39,5	16	250	310	257	22380.0103		
20	50	25,0	28	20,5	49,9	20	250	301	403	22380.0111		
20	60	25,0	28	20,5	49,9	20	250	326	403	22380.0112		
20	70	25,0	28	20,5	49,9	20	250	351	403	22380.0113		

¹⁾ 抗剪力類似 DIN 50141

d ₁ -0,04 -0,08	l ₁ +0,6	尺寸				定位孔 H11 [mm]	🌡️ max. [°C]	📦 [g]	剪力抵抗 力，加倍的 ¹⁾ min [kN]	品號
		d ₂	d ₃	l ₂ ±1	l ₃					
20	80	25,0	28	20,5	49,9	20	250	375	403	22380.0116
20	90	25,0	28	20,5	49,9	20	250	399	403	22380.0117
20	100	25,0	28	20,5	49,9	20	250	423	403	22380.0120
20	110	25,0	28	20,5	49,9	20	250	448	403	22380.0121
20	120	25,0	28	20,5	49,9	20	250	472	403	22380.0124
20	130	25,0	28	20,5	49,9	20	250	498	403	22380.0125
20	140	25,0	28	20,5	49,9	20	250	520	403	22380.0126
20	150	25,0	28	20,5	49,9	20	250	546	403	22380.0127
25	50	30,8	28	22,0	49,9	25	250	399	631	22380.0129
25	60	30,8	28	22,0	49,9	25	250	437	631	22380.0130
25	70	30,8	28	22,0	49,9	25	250	477	631	22380.0131
25	80	30,8	28	22,0	49,9	25	250	513	631	22380.0132
25	90	30,8	28	22,0	49,9	25	250	551	631	22380.0133
25	100	30,8	28	22,0	49,9	25	250	588	631	22380.0134
25	110	30,8	28	22,0	49,9	25	250	627	631	22380.0135
25	120	30,8	28	22,0	49,9	25	250	664	631	22380.0136
25	130	30,8	28	22,0	49,9	25	250	703	631	22380.0137
25	140	30,8	28	22,0	49,9	25	250	743	631	22380.0138
25	150	30,8	28	22,0	49,9	25	250	779	631	22380.0139

¹⁾ 抗剪力類似 DIN 50141

應用範例



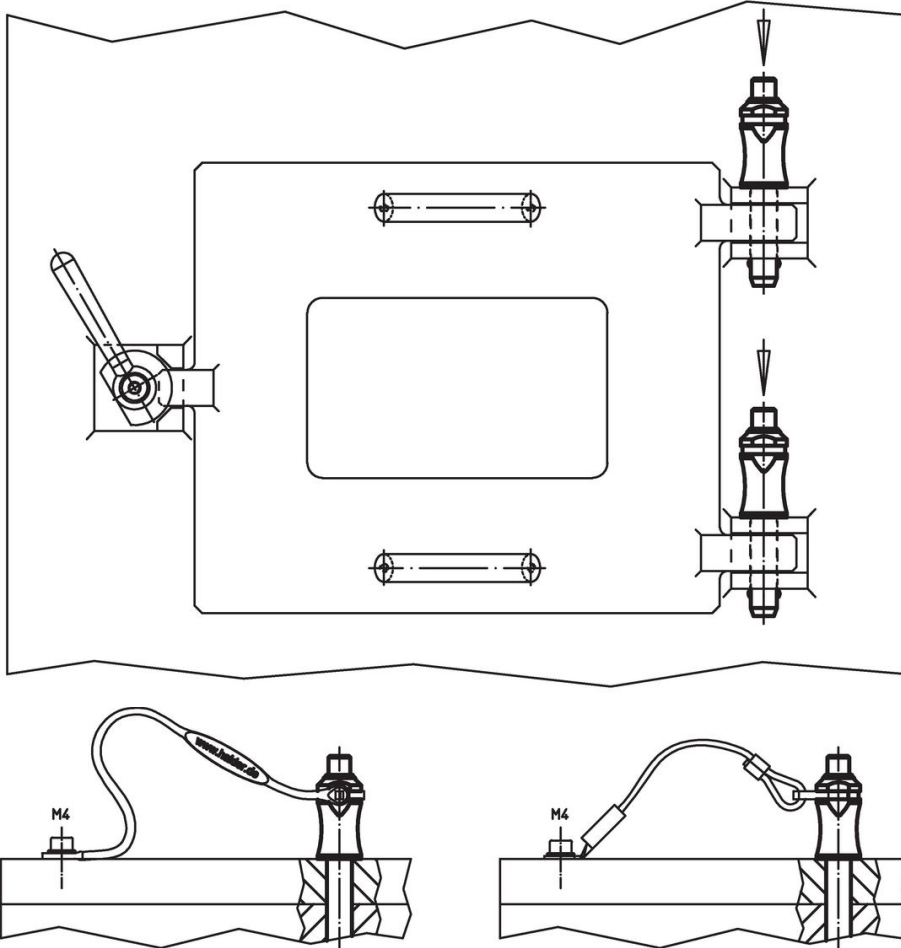

遵守

符合 RoHS

符合指令 2011/65/EU 和指令 2015/863

不含 SVHC 物質

不含超過 0.1% w/w 的 SVHC 物質 - 截至 2024 年 6 月 27 日的 SVHC 清單。

不含 65 號提案物質

不包括 65 號提案物質

<https://www.P65Warnings.ca.gov/>

不含衝突礦物

本產品不含來自剛果民主共和國或鄰近國家的任何被指定為“衝突礦物”的物質，例如鈿、錫、金或鎢。