

分割螺栓 · 無螺紋，有焊接

22120.1915



產品描述

索引螺栓用於索引

This index bolt made of steel or stainless steel is available in two versions.

- riveted
- screwed

材質

固定梢子

- 不銹鋼 1.4401

組裝

We recommend the screwed version for welded joints. The final assembly of the index bolt can then take place after the body has been welded:

1. Weld on body (3)
2. Place the spring (2) on the locking pin (1) and insert it into the body (3)
3. Tighten the bolt (4) with the screw (5) on the locking pin (1)

The riveted version is also suitable for fastening by welding. However, care must be taken to ensure that the effect of heat is limited (e.g. by fixing with weld spots) and that there are no structural changes to the spring and bolt.

操作

藉由旋轉分割螺栓 180°，銷子將會縮回並被固定在凹槽處 (此時銷子不會彈出)。

圖面

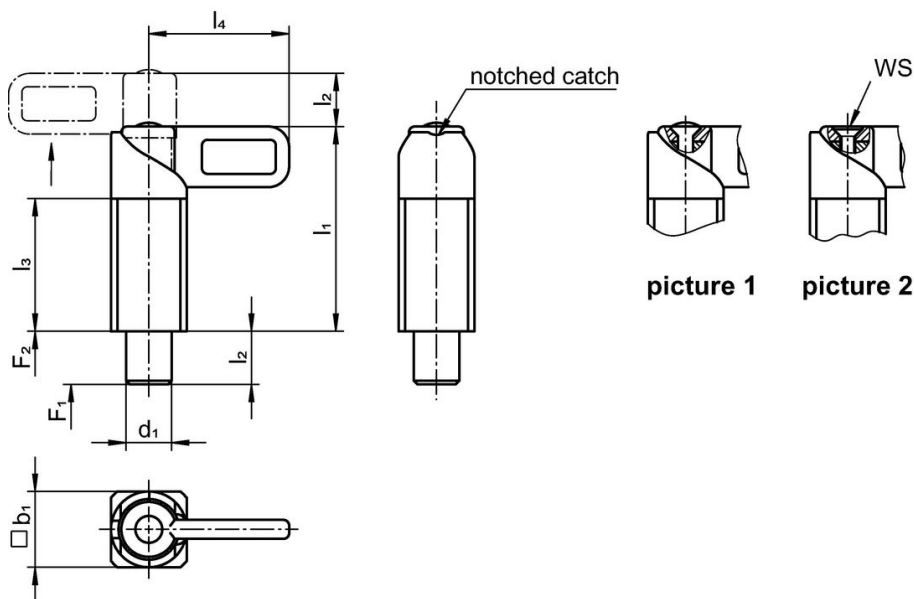

訂單資訊

尺寸						WS	彈簧荷重 ¹⁾		🔥	🔩	品號
d ₁	b ₁	l ₁	l ₂	l ₃	l ₄		F ₁	F ₂	max.		
-0.05		~					[N]		[°C]		[g]
-0.25						[mm]					
screwable (removable) – 相片 2											
12	20	54	14	35	37	2,5	14	35	250	168	22120.1915

¹⁾ 統計平均值

應用範例



遵守

符合 RoHS

符合指令 2011/65/EU 和指令 2015/863

不含 SVHC 物質

不含超過 0.1% w/w 的 SVHC 物質 - 截至 2024 年 1 月 23 日的 SVHC 清單。

不含 65 號提案物質

不包括 65 號提案物質

<https://www.P65Warnings.ca.gov/>

不含衝突礦物

本產品不含來自剛果民主共和國或鄰近國家的任何被指定為“衝突礦物”的物質，例如鉭、錫、金或鎢。