

Kogeldrukbouten • zonder kop, volle kogel

EH 22720.



Productbeschrijving

Kogeldrukschroeven met een thermoplast kogel zijn geschikt voor broze, drukgevoelige delen. Ook voor positioneren, klemmen, pannen of steunen bij oppervlaktes die niet exact parallel zijn.

Materiaal

Kogel

- kogellagerstaal, gehard
- RVS, gehard
- thermoplast (POM), wit

Schroef

- temperstaal, veredeld, $1200 \pm 100 \text{ N/mm}^2$
- RVS 1.4305

Meer informatie

Opmerkingen

Kogel niet geborgd tegen verdraaien.
Speciale uitvoeringen op aanvraag.

Verwijzingen

Schroefdraadborging op aanvraag, zie bijlage
- Technische gegevens -

Overige producten

- Kogeldrukbouten, zonder kop, met fijndraad
- Kogeldrukbouten, zonder kop, volle kogel en zeskant

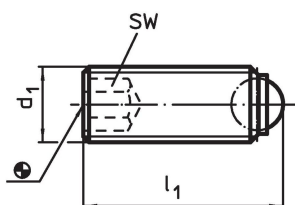

Tekening





Bestelinformatie

d ₁	Afmetingen		SW	Belastbaarheid bij statische belasting ¹⁾ max. [kN]	min. — max.		[g]	Artikelnr.
	l ₁	Kogel diameter			[°C]			
[mm]								
volle kogel, temperstaal								
M 3	5,0	1,5	1,5	2,5	–	250	0,1	22720.0032
M 3	7,5	1,5	1,5	2,5	–	250	0,2	22720.0033
M 3	10,0	1,5	1,5	2,5	–	250	0,3	22720.0034
M 4	6,0	2,5	2,0	3,5	–	250	0,3	22720.0042
M 4	8,0	2,5	2,0	3,5	–	250	0,4	22720.0043
M 4	10,0	2,5	2,0	3,5	–	250	0,5	22720.0044
M 4	12,0	2,5	2,0	3,5	–	250	0,7	22720.0045
M 4	16,0	2,5	2,0	3,5	–	250	1,0	22720.0046
M 5	8,0	3,0	2,5	4,5	–	250	0,7	22720.0052
M 5	10,0	3,0	2,5	4,5	–	250	0,9	22720.0053
M 5	12,0	3,0	2,5	4,5	–	250	1,1	22720.0054
M 5	16,0	3,0	2,5	4,5	–	250	1,6	22720.0055
M 5	20,0	3,0	2,5	4,5	–	250	2,0	22720.0056
M 5	25,0	3,0	2,5	4,5	–	250	2,6	22720.0058
M 6	10,8	4,0	3,0	9,0	–	250	1,3	22720.0062
M 6	12,8	4,0	3,0	9,0	–	250	1,7	22720.0063
M 6	16,8	4,0	3,0	9,0	–	250	2,3	22720.0064
M 6	20,8	4,0	3,0	9,0	–	250	3,0	22720.0065
M 6	25,8	4,0	3,0	9,0	–	250	3,8	22720.0066
M 8	11,2	5,5	4,0	15,0	–	250	2,5	22720.0081
M 8	13,2	5,5	4,0	15,0	–	250	2,8	22720.0082
M 8	17,2	5,5	4,0	15,0	–	250	4,0	22720.0083
M 8	21,2	5,5	4,0	15,0	–	250	5,2	22720.0084
M 8	26,2	5,5	4,0	15,0	–	250	6,7	22720.0085



¹⁾ Gegevens over belastbaarheid gelden niet voor uitvoeringen van RVS (behalve bij uitvoeringen met thermoplast kogel).

d ₁	Afmetingen		SW	Belastbaarheid bij statische belasting ¹⁾ max. [kN]	 min. max. [°C]		 [g]	Artikelnr.
	l ₁	Kogel diameter			[mm]	[mm]		
M 8	31,2	5,5	4,0	15,0	–	250	8,3	22720.0086
M10	13,7	7,0	5,0	20,0	–	250	4,7	22720.0101
M10	17,7	7,0	5,0	20,0	–	250	6,0	22720.0102
M10	21,7	7,0	5,0	20,0	–	250	8,0	22720.0103
M10	26,7	7,0	5,0	20,0	–	250	10,0	22720.0104
M10	31,7	7,0	5,0	20,0	–	250	13,0	22720.0105
M10	36,7	7,0	5,0	20,0	–	250	15,0	22720.0106
M10	41,7	7,0	5,0	20,0	–	250	18,0	22720.0108
M12	18,0	8,5	6,0	30,0	–	250	9,2	22720.0121
M12	22,0	8,5	6,0	30,0	–	250	11,0	22720.0122
M12	27,0	8,5	6,0	30,0	–	250	14,0	22720.0123
M12	32,0	8,5	6,0	30,0	–	250	18,0	22720.0124
M12	42,0	8,5	6,0	30,0	–	250	25,0	22720.0126
M12	52,0	8,5	6,0	30,0	–	250	32,0	22720.0128
M16	23,3	12,0	8,0	60,0	–	250	22,0	22720.0161
M16	28,3	12,0	8,0	60,0	–	250	27,0	22720.0162
M16	38,3	12,0	8,0	60,0	–	250	41,0	22720.0164
M16	53,3	12,0	8,0	60,0	–	250	61,0	22720.0166
M20	34,2	15,0	10,0	90,0	–	250	52,0	22720.0202
M20	44,2	15,0	10,0	90,0	–	250	73,0	22720.0204
M20	54,2	15,0	10,0	90,0	–	250	94,0	22720.0205
M20	64,2	15,0	10,0	90,0	–	250	114,0	22720.0206
M24	39,7	18,0	12,0	120,0	–	250	89,0	22720.0242
M24	54,7	18,0	12,0	120,0	–	250	133,0	22720.0244
M24	84,7	18,0	12,0	120,0	–	250	223,0	22720.0246
volle kogel, Roestvast staal								
M 3	5,0	1,5	1,5	2,5	–	250	0,1	22720.0747
M 3	7,5	1,5	1,5	2,5	–	250	0,2	22720.0748
M 3	10,0	1,5	1,5	2,5	–	250	0,3	22720.0749
M 4	6,0	2,5	2,0	3,5	–	250	0,3	22720.0750
M 4	8,0	2,5	2,0	3,5	–	250	0,4	22720.0752
M 4	10,0	2,5	2,0	3,5	–	250	0,5	22720.0754
M 4	12,0	2,5	2,0	3,5	–	250	0,7	22720.0756
M 4	16,0	2,5	2,0	3,5	–	250	1,0	22720.0758
M 5	8,0	3,0	2,5	4,5	–	250	0,7	22720.0760
M 5	10,0	3,0	2,5	4,5	–	250	0,9	22720.0761
M 5	12,0	3,0	2,5	4,5	–	250	1,1	22720.0762
M 5	16,0	3,0	2,5	4,5	–	250	1,6	22720.0763
M 5	20,0	3,0	2,5	4,5	–	250	2,0	22720.0764
M 5	25,0	3,0	2,5	4,5	–	250	2,6	22720.0765
M 6	10,8	4,0	3,0	9,0	–	250	1,3	22720.0770
M 6	12,8	4,0	3,0	9,0	–	250	1,7	22720.0772
M 6	16,8	4,0	3,0	9,0	–	250	2,3	22720.0774
M 6	20,8	4,0	3,0	9,0	–	250	3,0	22720.0775
M 6	25,8	4,0	3,0	9,0	–	250	3,8	22720.0776
M 8	11,2	5,5	4,0	15,0	–	250	2,5	22720.0780
M 8	13,2	5,5	4,0	15,0	–	250	2,8	22720.0782
M 8	17,2	5,5	4,0	15,0	–	250	4,0	22720.0783
M 8	21,2	5,5	4,0	15,0	–	250	5,2	22720.0784
M 8	26,2	5,5	4,0	15,0	–	250	6,7	22720.0785
M 8	31,2	5,5	4,0	15,0	–	250	8,3	22720.0786
M10	13,7	7,0	5,0	20,0	–	250	4,7	22720.0790
M10	17,7	7,0	5,0	20,0	–	250	6,0	22720.0792
M10	21,7	7,0	5,0	20,0	–	250	8,0	22720.0793
M10	26,7	7,0	5,0	20,0	–	250	10,0	22720.0794
M10	31,7	7,0	5,0	20,0	–	250	13,0	22720.0795
M10	36,7	7,0	5,0	20,0	–	250	15,0	22720.0796
M10	41,7	7,0	5,0	20,0	–	250	18,0	22720.0798
M12	18,0	8,5	6,0	30,0	–	250	9,2	22720.0800

¹⁾ Gegevens over belastbaarheid gelden niet voor uitvoeringen van RVS (behalve bij uitvoeringen met thermoplast kogel).

d ₁	Afmetingen		SW	Belastbaarheid bij statische belasting ¹⁾ max. [kN]	 min. max. [°C]		 [g]	Artikelnr.
	l ₁	Kogel diameter						
	[mm]		[mm]					
M12	22,0	8,5	6,0	30,0	–	250	11,0	22720.0802
M12	27,0	8,5	6,0	30,0	–	250	14,0	22720.0803
M12	32,0	8,5	6,0	30,0	–	250	18,0	22720.0804
M12	42,0	8,5	6,0	30,0	–	250	25,0	22720.0806
M12	52,0	8,5	6,0	30,0	–	250	32,0	22720.0808
M16	23,3	12,0	8,0	60,0	–	250	22,0	22720.0810
M16	28,3	12,0	8,0	60,0	–	250	27,0	22720.0812
M16	38,3	12,0	8,0	60,0	–	250	41,0	22720.0814
M16	53,3	12,0	8,0	60,0	–	250	61,0	22720.0816
volle kogel uit thermoplast, Roestvast staal								
M 4	6,0	2,5	2,0	0,3	-30	80	0,2	22720.0252
M 4	8,0	2,5	2,0	0,3	-30	80	0,4	22720.0253
M 4	10,0	2,5	2,0	0,3	-30	80	0,5	22720.0254
M 4	12,0	2,5	2,0	0,3	-30	80	0,6	22720.0255
M 4	16,0	2,5	2,0	0,3	-30	80	0,9	22720.0256
M 5	8,0	3,0	2,5	0,5	-30	80	0,8	22720.0262
M 5	10,0	3,0	2,5	0,5	-30	80	0,7	22720.0263
M 5	12,0	3,0	2,5	0,5	-30	80	1,0	22720.0264
M 5	16,0	3,0	2,5	0,5	-30	80	1,5	22720.0265
M 5	20,0	3,0	2,5	0,5	-30	80	1,9	22720.0266
M 5	25,0	3,0	2,5	0,5	-30	80	2,5	22720.0267
M 6	10,8	4,0	3,0	0,9	-30	80	1,1	22720.0272
M 6	12,8	4,0	3,0	0,9	-30	80	1,4	22720.0273
M 6	16,8	4,0	3,0	0,9	-30	80	2,1	22720.0274
M 6	20,8	4,0	3,0	0,9	-30	80	2,8	22720.0275
M 6	25,8	4,0	3,0	0,9	-30	80	3,6	22720.0276
M 8	11,2	5,5	4,0	1,5	-30	80	1,9	22720.0281
M 8	13,2	5,5	4,0	1,5	-30	80	2,3	22720.0282
M 8	17,2	5,5	4,0	1,5	-30	80	3,6	22720.0283
M 8	21,2	5,5	4,0	1,5	-30	80	4,6	22720.0284
M 8	26,2	5,5	4,0	1,5	-30	80	6,3	22720.0285
M 8	31,2	5,5	4,0	1,5	-30	80	7,7	22720.0286
M10	13,7	7,0	5,0	2,0	-30	80	3,5	22720.0291
M10	17,7	7,0	5,0	2,0	-30	80	4,9	22720.0292
M10	21,7	7,0	5,0	2,0	-30	80	6,8	22720.0293
M10	26,7	7,0	5,0	2,0	-30	80	9,2	22720.0294
M10	31,7	7,0	5,0	2,0	-30	80	12,0	22720.0295
M10	36,7	7,0	5,0	2,0	-30	80	14,0	22720.0296
M10	41,7	7,0	5,0	2,0	-30	80	16,0	22720.0297
M12	18,0	8,5	6,0	3,0	-30	80	7,1	22720.0301
M12	22,0	8,5	6,0	3,0	-30	80	8,8	22720.0302
M12	27,0	8,5	6,0	3,0	-30	80	12,0	22720.0303
M12	32,0	8,5	6,0	3,0	-30	80	16,0	22720.0304
M12	42,0	8,5	6,0	3,0	-30	80	23,0	22720.0306
M12	52,0	8,5	6,0	3,0	-30	80	30,0	22720.0308
volle kogel uit thermoplast, temperstaal								
M 4	6,0	2,5	2,0	0,3	-30	80	0,2	22720.0342
M 4	8,0	2,5	2,0	0,3	-30	80	0,4	22720.0343
M 4	10,0	2,5	2,0	0,3	-30	80	0,5	22720.0344
M 4	12,0	2,5	2,0	0,3	-30	80	0,6	22720.0345
M 4	16,0	2,5	2,0	0,3	-30	80	0,9	22720.0346
M 5	8,0	3,0	2,5	0,5	-30	80	0,8	22720.0352
M 5	10,0	3,0	2,5	0,5	-30	80	0,7	22720.0353
M 5	12,0	3,0	2,5	0,5	-30	80	1,0	22720.0354
M 5	16,0	3,0	2,5	0,5	-30	80	1,5	22720.0355
M 5	20,0	3,0	2,5	0,5	-30	80	1,9	22720.0356
M 5	25,0	3,0	2,5	0,5	-30	80	2,5	22720.0358
M 6	10,8	4,0	3,0	0,9	-30	80	1,1	22720.0362
M 6	12,8	4,0	3,0	0,9	-30	80	1,4	22720.0363

¹⁾ Gegevens over belastbaarheid gelden niet voor uitvoeringen van RVS (behalve bij uitvoeringen met thermoplast kogel).

d ₁	Afmetingen		SW [mm]	Belastbaarheid bij statische belasting ¹⁾ max. [kN]	 min. max. [°C]		 [g]	Artikelnr.
	l ₁ [mm]	Kogel diameter						
M 6	16,8	4,0	3,0	0,9	-30	80	2,1	22720.0364
M 6	20,8	4,0	3,0	0,9	-30	80	2,8	22720.0365
M 6	25,8	4,0	3,0	0,9	-30	80	3,6	22720.0366
M 8	11,2	5,5	4,0	1,5	-30	80	1,9	22720.0381
M 8	13,2	5,5	4,0	1,5	-30	80	2,3	22720.0382
M 8	17,2	5,5	4,0	1,5	-30	80	3,6	22720.0383
M 8	21,2	5,5	4,0	1,5	-30	80	4,6	22720.0384
M 8	26,2	5,5	4,0	1,5	-30	80	6,3	22720.0385
M 8	31,2	5,5	4,0	1,5	-30	80	7,7	22720.0386
M10	13,7	7,0	5,0	2,0	-30	80	3,5	22720.0401
M10	17,7	7,0	5,0	2,0	-30	80	4,9	22720.0402
M10	21,7	7,0	5,0	2,0	-30	80	6,8	22720.0403
M10	26,7	7,0	5,0	2,0	-30	80	9,2	22720.0404
M10	31,7	7,0	5,0	2,0	-30	80	12,0	22720.0405
M10	36,7	7,0	5,0	2,0	-30	80	14,0	22720.0406
M10	41,7	7,0	5,0	2,0	-30	80	16,0	22720.0408
M12	18,0	8,5	6,0	3,0	-30	80	7,1	22720.0421
M12	22,0	8,5	6,0	3,0	-30	80	8,8	22720.0422
M12	27,0	8,5	6,0	3,0	-30	80	12,0	22720.0423
M12	32,0	8,5	6,0	3,0	-30	80	16,0	22720.0424
M12	42,0	8,5	6,0	3,0	-30	80	23,0	22720.0426
M12	52,0	8,5	6,0	3,0	-30	80	30,0	22720.0428

¹⁾ Gegevens over belastbaarheid gelden niet voor uitvoeringen van RVS (behalve bij uitvoeringen met thermoplast kogel).

Toepassingsvoorbeeld

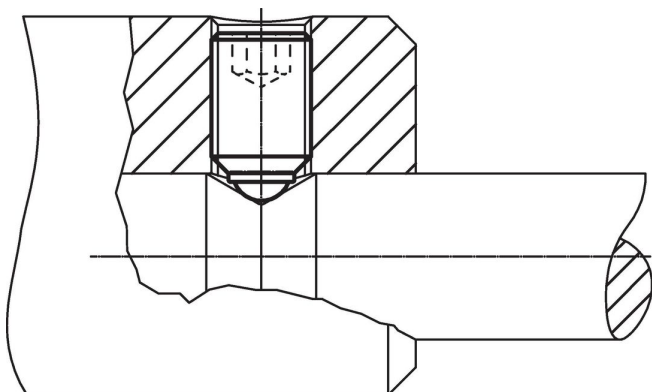

Voldoet

Selecteer voor gedetailleerde informatie over de naleving het gewenste artikelnummer.