

스프링 플런저

인치(INCH) 버전

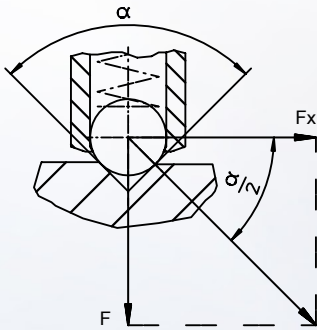

부하 저항 계산



$$F_x = \frac{F}{\tan \frac{\alpha}{2}}$$

계산 예:
 $\alpha = 60^\circ, F_x = 1,732 \times F$
 $\alpha = 90^\circ, F_x = F$
 $\alpha = 120^\circ, F_x = 0,577 \times F$

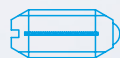

경하중 스프링

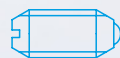

일반 스프링

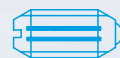

고하중 스프링



www.halder.com/kr/SpringPlungers-Video_kr

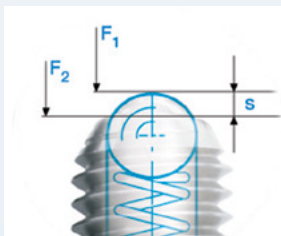

보증

스프링력 F1와 F2 그리고 s 범위는 테스트를 거쳐 정확한 값을 보증.

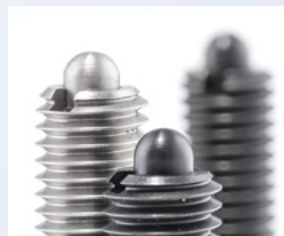

고품질

경화처리 된 볼트의 사용으로 성능이 우수하며 마모가 적음.

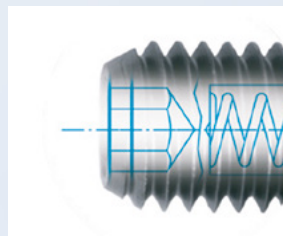

안전

특정 제조 공정과 조립 순서 덕분에 뛰어난 기능적 신뢰성을 가짐.



명확

몸체에 영구적인 표시를 함으로써, 스프링력에 대하여 일관성있고, 명확한 식별을 할 수 있도록 함.