

Star Grips • DIN 6336 stainless steel die-cast
EH 24661.



Product Description

These star grips are manufactured according to DIN 6336.

Material

Handle

- Stainless steel A2, dull blasted

Drawing

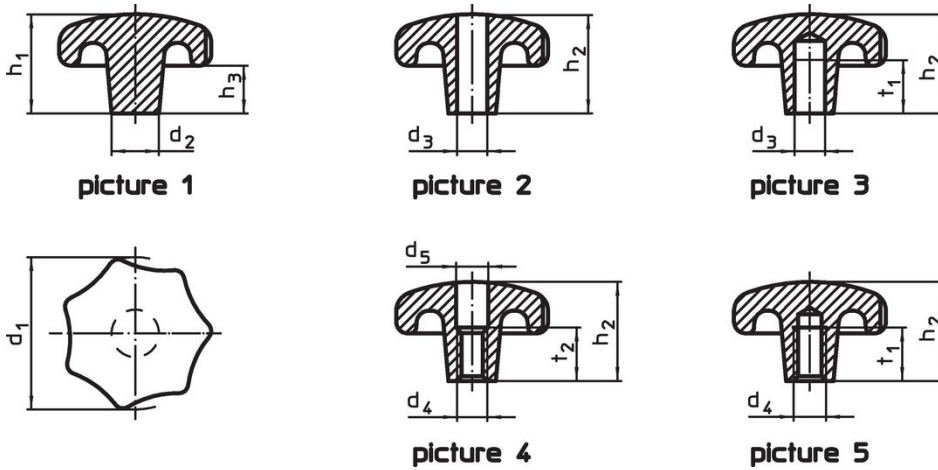

Order information

d ₁	d ₂	d ₄	Dimensions						[g]	Art. No.	
			d ₅	h ₁	h ₂	h ₃	t ₁ min.	t ₂			
[mm]											
raw part, form A – picture 1											
32	12	–	–	21	–	–	10	–	–	56	24661.0032
40	14	–	–	26	–	–	13	–	–	85	24661.0040
50	18	–	–	34	–	–	17	–	–	181	24661.0050
63	20	–	–	42	–	–	21	–	–	319	24661.0063
with thread, drilled out, form D – picture 4											
32	12	M 6	6.4	–	20	–	–	–	10	52	24661.0332
40	14	M 8	8.4	–	25	–	–	–	13	75	24661.0340
50	18	M10	10.5	–	32	–	–	–	16	149	24661.0350
63	20	M12	13.0	–	40	–	–	–	20	279	24661.0363
with threaded blind hole, form E – picture 5											
32	12	M 6	–	–	20	–	–	12	–	53	24661.0432
40	14	M 8	–	–	25	–	–	15	–	77	24661.0440
50	18	M10	–	–	32	–	–	18	–	158	24661.0450
63	20	M12	–	–	40	–	–	22	–	296	24661.0463

Compliance

RoHS compliant

Compliant according to Directive 2011/65/EU and Directive 2015/863.

Does not contain SVHC substances

No SVHC substances with more than 0.1% w/w contained - SVHC list [REACH] as of 27.06.2024.

Does not contain Proposition 65 substances

No Proposition 65 substances included.

<https://www.P65Warnings.ca.gov/>

Free from Conflict Minerals

This product does not contain any substances designated as "conflict minerals" such as tantalum, tin, gold or tungsten from the Democratic Republic of Congo or adjacent countries.