

Tommy Screws • DIN 6304 with fixed pin EH 24490.



Product Description

With this version, the pin is pressed in.

Material

- Free cutting steel, blackened, pressure lug hardened.

More information

References

Thrust point for thrust pad DIN 6311 form S, EH 22560.

Further products

- Thrust Pads, DIN 6311 and low model

Drawing

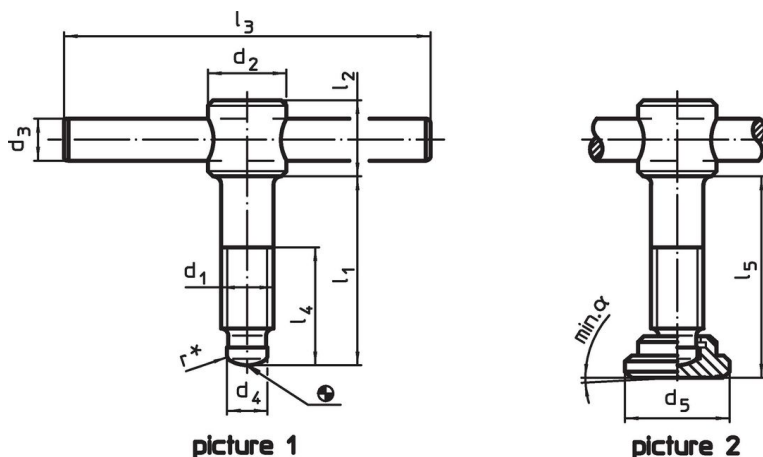

* to ease assembly the DIN 6304 specification has been completed by r

Order information

d ₁	l ₁	d ₂	d ₃	Dimensions						α min.	[g]	Art. No.
				d ₄	d ₅	l ₂	l ₃	l ₄	l ₅			
[mm]												
without thrust pad, form E – picture 1												
M 6	40	12	5	4.5	–	10	50	30	–	–	21	24490.0006
M 6	50	12	5	4.5	–	10	50	40	–	–	23	24490.0007
M 8	50	14	6	6.0	–	12	60	35	–	–	39	24490.0008
M 8	60	14	6	6.0	–	12	60	45	–	–	43	24490.0009
M10	60	18	8	8.0	–	14	80	40	–	–	81	24490.0010
M10	70	18	8	8.0	–	14	80	50	–	–	86	24490.0011
M12	70	20	10	8.0	–	18	100	50	–	–	141	24490.0012
M12	80	20	10	8.0	–	18	100	60	–	–	148	24490.0013
M16	75	24	12	12.0	–	20	120	55	–	–	249	24490.0016
M16	90	24	12	12.0	–	20	120	70	–	–	268	24490.0017
M16	110	24	12	12.0	–	20	120	90	–	–	294	24490.0018
M20	75	30	16	15.5	–	28	140	55	–	–	475	24490.0020
M20	90	30	16	15.5	–	28	140	70	–	–	504	24490.0021
M20	110	30	16	15.5	–	28	140	90	–	–	544	24490.0022
with thrust pad, form F – picture 2												
M 6	40	12	5	4.5	12	10	50	30	42.1	7°	24	24490.0106
M 6	50	12	5	4.5	12	10	50	40	52.1	7°	28	24490.0107
M 8	50	14	6	6.0	16	12	60	35	53.0	4°	49	24490.0108
M 8	60	14	6	6.0	16	12	60	45	63.0	4°	54	24490.0109
M10	60	18	8	8.0	20	14	80	40	63.6	3°	97	24490.0110
M10	70	18	8	8.0	20	14	80	50	73.6	3°	102	24490.0111
M12	70	20	10	8.0	25	18	100	50	74.6	3°	173	24490.0112
M12	80	20	10	8.0	25	18	100	60	84.6	3°	178	24490.0113

d ₁	l ₁	d ₂	d ₃	Dimensions						α min.		Art. No.
				d ₄	d ₅	l ₂	l ₃ ~	l ₄	l ₅ ~			
[mm]												
M16	75	24	12	12.0	32	20	120	55	80.4	5°	317	24490.0116
M16	90	24	12	12.0	32	20	120	70	95.4	5°	342	24490.0117
M16	110	24	12	12.0	32	20	120	90	115.4	5°	367	24490.0118
M20	75	30	16	15.5	40	28	140	55	80.5	4°	573	24490.0120
M20	90	30	16	15.5	40	28	140	70	95.5	4°	603	24490.0121
M20	110	30	16	15.5	40	28	140	90	115.5	4°	643	24490.0122

Compliance

RoHS compliant

Contains lead - compliant according to exceptions 6a / 6b / 6c.

Contains SVHC substances >0,1% w/w

Contains lead - SVHC list [REACH] as of 23.01.2024.

Contains Proposition 65 substances



Lead can cause cancer and reproductive harm from exposure
<https://www.P65Warnings.ca.gov/>

Free from Conflict Minerals

This product does not contain any substances designated as "conflict minerals" such as tantalum, tin, gold or tungsten from the Democratic Republic of Congo or adjacent countries.