

Retrieval Units · with sensor EH 22810.



Product Description

For retrieve a workpiece on a seating element.

The retrieval unit is always built into a seating element as a single system. By means of a simple plug-in connection, it transmits whether a part is located at a specific position, as an electrical signal.

The retrieval unit can be used in combination with various seating elements. For example, the EH 22690 pins from the Halder standard parts are suitable.

Data is transferred via a cable connection. Optionally, the retrieval signal can be transferred by radio. The version with bushing must be used to connect the retrieval unit to the radio transmitter. The retrieval unit meets the requirements of protection class IP6K7 (highly temperature-resistant and robust).

Material

Cable

- Silicone

Sensor

- Plastic, black

Plug

- Metal

Body

- Aluminium, blue anodised

Body

- Heat-treated steel, tempered, blackened

More information

Notes

Further information on request.

Erwin Halder KG is a registered electrical equipment manufacturer (WEEE-Reg. No. DE 47048902).



Further products

- Index Plungers, with sensor
- Pins
- Pins, with plastic bearing surface
- Radio Transmitters, for retrieval unit
- Radio Receivers, for retrieval unit
- Sensing Elements, with sensor adapter
- Sensing Elements, with actuating bolt, protected against rotating

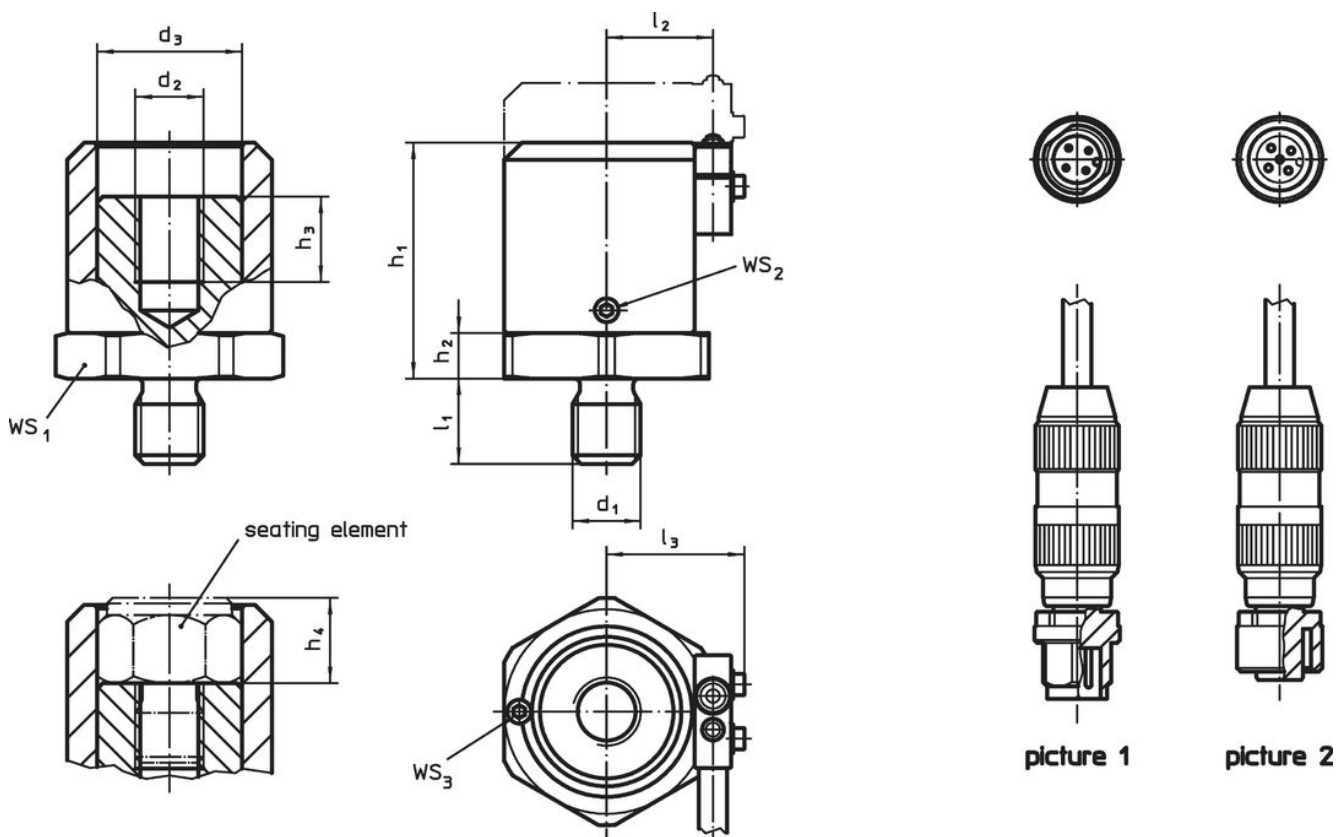

Drawing



Order information

Dimensions												WS			 min. max.		 [g]	Art. No.
d ₁	d ₂	d ₃	l ₁	l ₂	l ₃	h ₁ min.	h ₁ max.	h ₂	h ₃	h ₄ min.	h ₄ max.	WS ₁	WS ₂	WS ₃	min.	max.		
[mm]												[mm]			[°C]		[g]	
retrieval unit with bushing – picture 1																		
M 8	M 8	20.3	12	15.8	21.4	30.5	40.5	5	12	10	20.0	30	1.5	1.5	-25	85	180	22810.0008
M12	M12	25.5	15	18.7	24.3	41.5	59.0	8	15	10	27.5	36	2.0	2.0	-25	85	344	22810.0012
retrieval unit with plug – picture 2																		
M 8	M 8	20.3	12	15.8	21.4	30.5	40.5	5	12	10	20.0	30	1.5	1.5	-25	85	180	22810.1008
M12	M12	25.5	15	18.7	24.3	41.5	59.0	8	15	10	27.5	36	2.0	2.0	-25	85	408	22810.1012

Accessories

	 [g]	Art. No.
sensor with bush and silicone cable		
	99	22810.9001
sensor with plug and silicone cable		
 No Photo available	96	22810.9002

Application example

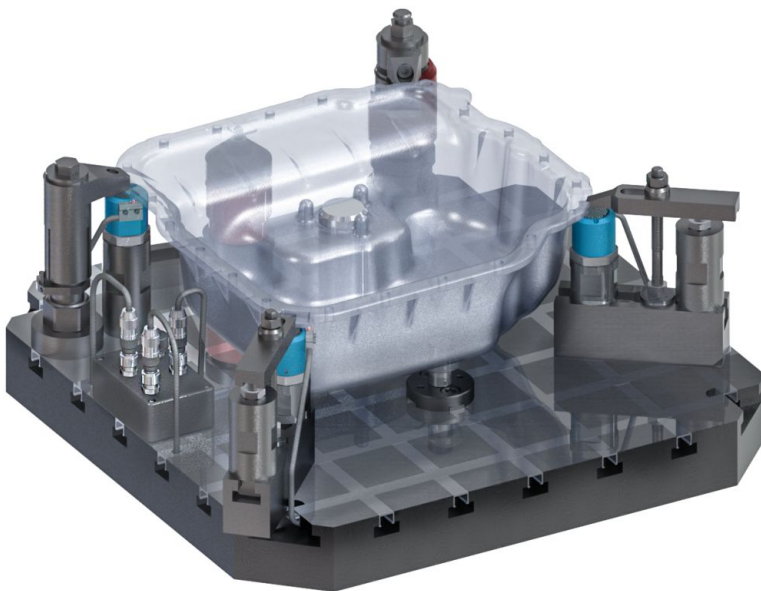

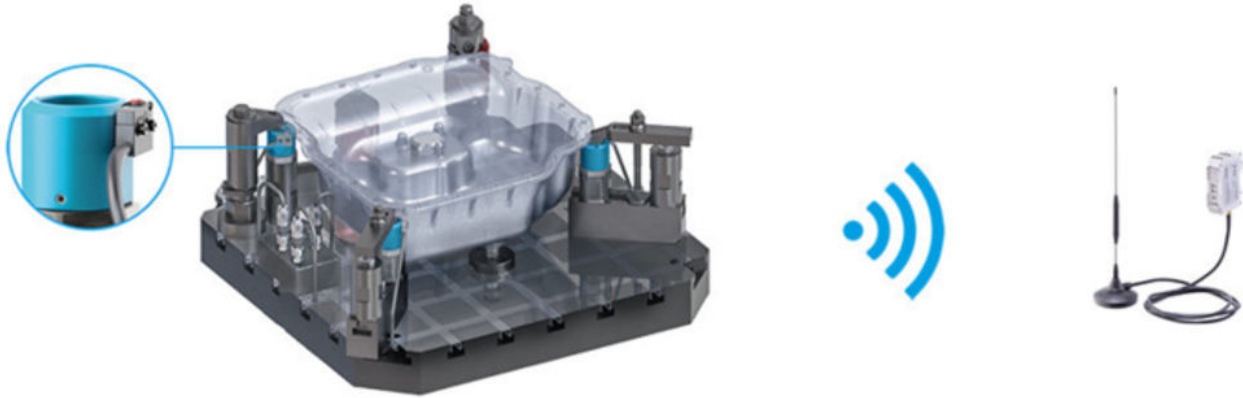

Compliance

For detailed compliance information please select the desired article number.