

Ball Lock Pins • self-locking, with combination handle

EH 22370.



Product Description

For quick fastening, locking, adjusting, changing and securing. Quickly and easily unlockable for frequently repeated connections.

All versions are corrosion resistant.

Ergonomic grip, different colour combinations available. The grip design provides protection of unintentional unlocking.

Material

Pin part

- Stainless steel 1.4305

Handle

- Thermoplastic PA 6 grey / orange
- Thermoplastic PA 6 grey / grey
- Thermoplastic PA 6 grey / blue
- Thermoplastic PA 6 black / black

Spring

- Stainless steel

Operation

The balls are unlocked by pressing the button.

More information

Notes

Special types on request.

References

Stainless steel 1.4542, see EH 22380.

Accessories

Can easily be fitted with retaining cable EH 22400.

Further products

- Ball Lock Pins, self-locking, with combination handle, precipitation-hardened
- Locating Bushings, for ball lock pins and socket pins
- Locating Bushings, with flange, for ball lock pins and socket pins
- Retaining Cables
- Positioning Bushings, with collar, DIN 172 A
- Positioning Bushings, without collar, DIN 179 A

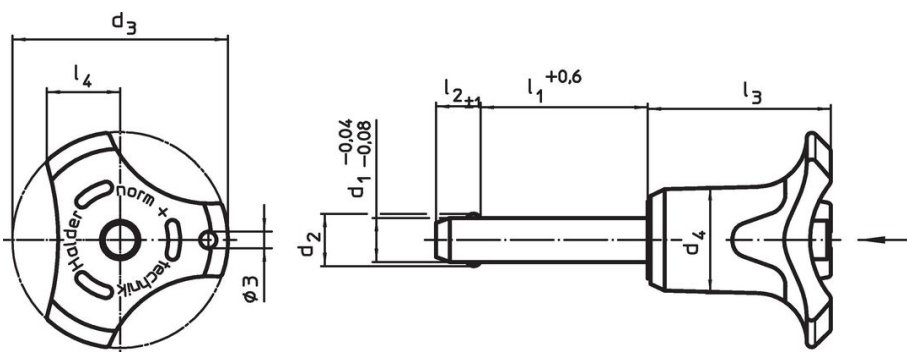

Drawing





Order information

Dimensions								Location hole H11 [mm]	Shearing resistance, two-shear ¹⁾ min. [kN]	Temperature		Weight [g]	Art. No.
d ₁	l ₁	d ₂	d ₃	d ₄	l ₂	l ₃	l ₄			min.	max.		
-0.04 -0.08	+0.6				±1								
[mm]													
[°C]													
[g]													
Handle colour: orange													
5	10	5.5	33.2	14.5	6.0	26.7	10.8	5	14	-30	80	21	22370.0152
5	15	5.5	33.2	14.5	6.0	26.7	10.8	5	14	-30	80	15	22370.0153
5	20	5.5	33.2	14.5	6.0	26.7	10.8	5	14	-30	80	16	22370.0154
5	25	5.5	33.2	14.5	6.0	26.7	10.8	5	14	-30	80	17	22370.0155
5	30	5.5	33.2	14.5	6.0	26.7	10.8	5	14	-30	80	18	22370.0156
5	35	5.5	33.2	14.5	6.0	26.7	10.8	5	14	-30	80	19	22370.0145



¹⁾ Shearing resistance similar to DIN 50141

d ₁ -0.04 -0.08	l ₁ +0.6	Dimensions						Location hole H11 [mm]	Shearing resistance, two-shear ¹⁾ min. [kN]	 min. max.		 [g]	Art. No.
		d ₂	d ₃	d ₄	l ₂ ±1	l ₃	l ₄			[°C]			
		[mm]											
5	40	5.5	33.2	14.5	6.0	26.7	10.8	5	14	-30	80	20	22370.0146
5	45	5.5	33.2	14.5	6.0	26.7	10.8	5	14	-30	80	21	22370.0147
5	50	5.5	33.2	14.5	6.0	26.7	10.8	5	14	-30	80	23	22370.0148
5	60	5.5	33.2	14.5	6.0	26.7	10.8	5	14	-30	80	21	22370.0149
5	70	5.5	33.2	14.5	6.0	26.7	10.8	5	14	-30	80	18	22370.0150
5	80	5.5	33.2	14.5	6.0	26.7	10.8	5	14	-30	80	19	22370.0151
6	10	7.0	33.2	14.5	7.0	26.7	10.8	6	21	-30	80	16	22370.0162
6	15	7.0	33.2	14.5	7.0	26.7	10.8	6	21	-30	80	17	22370.0163
6	20	7.0	33.2	14.5	7.0	26.7	10.8	6	21	-30	80	18	22370.0164
6	25	7.0	33.2	14.5	7.0	26.7	10.8	6	21	-30	80	19	22370.0165
6	30	7.0	33.2	14.5	7.0	26.7	10.8	6	21	-30	80	20	22370.0166
6	35	7.0	33.2	14.5	7.0	26.7	10.8	6	21	-30	80	21	22370.0167
6	40	7.0	33.2	14.5	7.0	26.7	10.8	6	21	-30	80	22	22370.0168
6	45	7.0	33.2	14.5	7.0	26.7	10.8	6	21	-30	80	23	22370.0169
6	50	7.0	33.2	14.5	7.0	26.7	10.8	6	21	-30	80	24	22370.0170
6	60	7.0	33.2	14.5	7.0	26.7	10.8	6	21	-30	80	26	22370.0157
6	70	7.0	33.2	14.5	7.0	26.7	10.8	6	21	-30	80	28	22370.0158
6	80	7.0	33.2	14.5	7.0	26.7	10.8	6	21	-30	80	30	22370.0159
8	10	9.5	39.2	18.4	8.2	33.3	13.4	8	38	-30	80	38	22370.0172
8	15	9.5	39.2	18.4	8.2	33.3	13.4	8	38	-30	80	37	22370.0173
8	20	9.5	39.2	18.4	8.2	33.3	13.4	8	38	-30	80	39	22370.0174
8	25	9.5	39.2	18.4	8.2	33.3	13.4	8	38	-30	80	42	22370.0175
8	30	9.5	39.2	18.4	8.2	33.3	13.4	8	38	-30	80	44	22370.0176
8	35	9.5	39.2	18.4	8.2	33.3	13.4	8	38	-30	80	46	22370.0177
8	40	9.5	39.2	18.4	8.2	33.3	13.4	8	38	-30	80	47	22370.0178
8	45	9.5	39.2	18.4	8.2	33.3	13.4	8	38	-30	80	49	22370.0179
8	50	9.5	39.2	18.4	8.2	33.3	13.4	8	38	-30	80	51	22370.0180
8	60	9.5	39.2	18.4	8.2	33.3	13.4	8	38	-30	80	62	22370.0181
8	70	9.5	39.2	18.4	8.2	33.3	13.4	8	38	-30	80	65	22370.0182
8	80	9.5	39.2	18.4	8.2	33.3	13.4	8	38	-30	80	69	22370.0183
8	90	9.5	39.2	18.4	8.2	33.3	13.4	8	38	-30	80	36	22370.0171
8	100	9.5	39.2	18.4	8.2	33.3	13.4	8	38	-30	80	54	22370.0161
10	15	12.0	39.2	18.4	9.6	33.3	13.4	10	60	-30	80	86	22370.0191
10	20	12.0	39.2	18.4	9.6	33.3	13.4	10	60	-30	80	46	22370.0184
10	25	12.0	39.2	18.4	9.6	33.3	13.4	10	60	-30	80	49	22370.0185
10	30	12.0	39.2	18.4	9.6	33.3	13.4	10	60	-30	80	53	22370.0186
10	35	12.0	39.2	18.4	9.6	33.3	13.4	10	60	-30	80	55	22370.0187
10	40	12.0	39.2	18.4	9.6	33.3	13.4	10	60	-30	80	57	22370.0188
10	45	12.0	39.2	18.4	9.6	33.3	13.4	10	60	-30	80	61	22370.0189
10	50	12.0	39.2	18.4	9.6	33.3	13.4	10	60	-30	80	64	22370.0190
10	60	12.0	39.2	18.4	9.6	33.3	13.4	10	60	-30	80	70	22370.0192
10	70	12.0	39.2	18.4	9.6	33.3	13.4	10	60	-30	80	91	22370.0193
10	80	12.0	39.2	18.4	9.6	33.3	13.4	10	60	-30	80	97	22370.0194
10	90	12.0	39.2	18.4	9.6	33.3	13.4	10	60	-30	80	103	22370.0195
10	100	12.0	39.2	18.4	9.6	33.3	13.4	10	60	-30	80	109	22370.0196
10	110	12.0	39.2	18.4	9.6	33.3	13.4	10	60	-30	80	115	22370.0197
10	120	12.0	39.2	18.4	9.6	33.3	13.4	10	60	-30	80	53	22370.0198
12	20	14.5	47.6	25.2	10.6	39.7	16.7	12	87	-30	80	91	22370.0204
12	25	14.5	47.6	25.2	10.6	39.7	16.7	12	87	-30	80	96	22370.0205
12	30	14.5	47.6	25.2	10.6	39.7	16.7	12	87	-30	80	100	22370.0206
12	35	14.5	47.6	25.2	10.6	39.7	16.7	12	87	-30	80	105	22370.0207
12	40	14.5	47.6	25.2	10.6	39.7	16.7	12	87	-30	80	109	22370.0208
12	45	14.5	47.6	25.2	10.6	39.7	16.7	12	87	-30	80	113	22370.0209
12	50	14.5	47.6	25.2	10.6	39.7	16.7	12	87	-30	80	117	22370.0210
12	60	14.5	47.6	25.2	10.6	39.7	16.7	12	87	-30	80	126	22370.0212
12	70	14.5	47.6	25.2	10.6	39.7	16.7	12	87	-30	80	134	22370.0214
12	80	14.5	47.6	25.2	10.6	39.7	16.7	12	87	-30	80	143	22370.0216
12	90	14.5	47.6	25.2	10.6	39.7	16.7	12	87	-30	80	165	22370.0217
12	100	14.5	47.6	25.2	10.6	39.7	16.7	12	87	-30	80	173	22370.0218



¹⁾ Shearing resistance similar to DIN 50141

d ₁ -0.04 -0.08	l ₁ +0.6	Dimensions						Location hole H11 [mm]	Shearing resistance, two-shear ¹⁾ min. [kN]	 min. max. [°C]		 [g]	Art. No.
		d ₂	d ₃	d ₄	l ₂ ±1	l ₃	l ₄			[mm]			
12	110	14.5	47.6	25.2	10.6	39.7	16.7	12	87	-30	80	182	22370.0219
12	120	14.5	47.6	25.2	10.6	39.7	16.7	12	87	-30	80	177	22370.0220
16	30	19.0	47.6	25.2	14.0	39.7	16.7	16	155	-30	80	132	22370.0226
16	35	19.0	47.6	25.2	14.0	39.7	16.7	16	155	-30	80	140	22370.0227
16	40	19.0	47.6	25.2	14.0	39.7	16.7	16	155	-30	80	148	22370.0228
16	45	19.0	47.6	25.2	14.0	39.7	16.7	16	155	-30	80	155	22370.0229
16	50	19.0	47.6	25.2	14.0	39.7	16.7	16	155	-30	80	168	22370.0230
16	60	19.0	47.6	25.2	14.0	39.7	16.7	16	155	-30	80	178	22370.0232
16	70	19.0	47.6	25.2	14.0	39.7	16.7	16	155	-30	80	194	22370.0234
16	80	19.0	47.6	25.2	14.0	39.7	16.7	16	155	-30	80	208	22370.0236
16	90	19.0	47.6	25.2	14.0	39.7	16.7	16	155	-30	80	234	22370.0237
16	100	19.0	47.6	25.2	14.0	39.7	16.7	16	155	-30	80	251	22370.0238
16	110	19.0	47.6	25.2	14.0	39.7	16.7	16	155	-30	80	266	22370.0239
16	120	19.0	47.6	25.2	14.0	39.7	16.7	16	155	-30	80	281	22370.0240
16	130	19.0	47.6	25.2	14.0	39.7	16.7	16	155	-30	80	297	22370.0241
16	140	19.0	47.6	25.2	14.0	39.7	16.7	16	155	-30	80	313	22370.0242
16	150	19.0	47.6	25.2	14.0	39.7	16.7	16	155	-30	80	328	22370.0243
20	50	25.0	57.1	33.8	20.5	50.7	21.5	20	244	-30	80	329	22370.0251
20	60	25.0	57.1	33.8	20.5	50.7	21.5	20	244	-30	80	343	22370.0252
20	70	25.0	57.1	33.8	20.5	50.7	21.5	20	244	-30	80	377	22370.0253
20	80	25.0	57.1	33.8	20.5	50.7	21.5	20	244	-30	80	392	22370.0256
20	90	25.0	57.1	33.8	20.5	50.7	21.5	20	244	-30	80	426	22370.0257
20	100	25.0	57.1	33.8	20.5	50.7	21.5	20	244	-30	80	444	22370.0260
20	110	25.0	57.1	33.8	20.5	50.7	21.5	20	244	-30	80	474	22370.0261
20	120	25.0	57.1	33.8	20.5	50.7	21.5	20	244	-30	80	488	22370.0264
20	130	25.0	57.1	33.8	20.5	50.7	21.5	20	244	-30	80	523	22370.0265
20	140	25.0	57.1	33.8	20.5	50.7	21.5	20	244	-30	80	546	22370.0266
20	150	25.0	57.1	33.8	20.5	50.7	21.5	20	244	-30	80	571	22370.0267
25	50	30.8	57.1	33.8	22.0	50.7	21.5	25	386	-30	80	415	22370.0269
25	60	30.8	57.1	33.8	22.0	50.7	21.5	25	386	-30	80	453	22370.0270
25	70	30.8	57.1	33.8	22.0	50.7	21.5	25	386	-30	80	503	22370.0271
25	80	30.8	57.1	33.8	22.0	50.7	21.5	25	386	-30	80	536	22370.0272
25	90	30.8	57.1	33.8	22.0	50.7	21.5	25	386	-30	80	565	22370.0273
25	100	30.8	57.1	33.8	22.0	50.7	21.5	25	386	-30	80	612	22370.0274
25	110	30.8	57.1	33.8	22.0	50.7	21.5	25	386	-30	80	640	22370.0275
25	120	30.8	57.1	33.8	22.0	50.7	21.5	25	386	-30	80	689	22370.0276
25	130	30.8	57.1	33.8	22.0	50.7	21.5	25	386	-30	80	715	22370.0277
25	140	30.8	57.1	33.8	22.0	50.7	21.5	25	386	-30	80	753	22370.0278
25	150	30.8	57.1	33.8	22.0	50.7	21.5	25	386	-30	80	811	22370.0279
Handle colour: grey													
5	10	5.5	33.2	14.5	6.0	26.7	10.8	5	14	-30	80	21	22370.0292
5	15	5.5	33.2	14.5	6.0	26.7	10.8	5	14	-30	80	15	22370.0293
5	20	5.5	33.2	14.5	6.0	26.7	10.8	5	14	-30	80	16	22370.0294
5	25	5.5	33.2	14.5	6.0	26.7	10.8	5	14	-30	80	17	22370.0295
5	30	5.5	33.2	14.5	6.0	26.7	10.8	5	14	-30	80	18	22370.0296
5	35	5.5	33.2	14.5	6.0	26.7	10.8	5	14	-30	80	19	22370.0285
5	40	5.5	33.2	14.5	6.0	26.7	10.8	5	14	-30	80	20	22370.0286
5	45	5.5	33.2	14.5	6.0	26.7	10.8	5	14	-30	80	21	22370.0287
5	50	5.5	33.2	14.5	6.0	26.7	10.8	5	14	-30	80	23	22370.0288
5	60	5.5	33.2	14.5	6.0	26.7	10.8	5	14	-30	80	21	22370.0289
5	70	5.5	33.2	14.5	6.0	26.7	10.8	5	14	-30	80	18	22370.0290
5	80	5.5	33.2	14.5	6.0	26.7	10.8	5	14	-30	80	19	22370.0291
6	10	7.0	33.2	14.5	7.0	26.7	10.8	6	21	-30	80	16	22370.0302
6	15	7.0	33.2	14.5	7.0	26.7	10.8	6	21	-30	80	17	22370.0303
6	20	7.0	33.2	14.5	7.0	26.7	10.8	6	21	-30	80	18	22370.0304
6	25	7.0	33.2	14.5	7.0	26.7	10.8	6	21	-30	80	19	22370.0305
6	30	7.0	33.2	14.5	7.0	26.7	10.8	6	21	-30	80	20	22370.0306
6	35	7.0	33.2	14.5	7.0	26.7	10.8	6	21	-30	80	21	22370.0307



¹⁾ Shearing resistance similar to DIN 50141

d ₁ -0.04 -0.08	l ₁ +0.6	Dimensions						Location hole H11 [mm]	Shearing resistance, two-shear ¹⁾ min. [kN]	 min. max. [°C]		 [g]	Art. No.
		d ₂	d ₃	d ₄	l ₂ ±1	l ₃	l ₄			[mm]			
6	40	7.0	33.2	14.5	7.0	26.7	10.8	6	21	-30	80	22	22370.0308
6	45	7.0	33.2	14.5	7.0	26.7	10.8	6	21	-30	80	23	22370.0309
6	50	7.0	33.2	14.5	7.0	26.7	10.8	6	21	-30	80	24	22370.0310
6	60	7.0	33.2	14.5	7.0	26.7	10.8	6	21	-30	80	26	22370.0297
6	70	7.0	33.2	14.5	7.0	26.7	10.8	6	21	-30	80	28	22370.0298
6	80	7.0	33.2	14.5	7.0	26.7	10.8	6	21	-30	80	30	22370.0299
8	10	9.5	39.2	18.4	8.2	33.3	13.4	8	38	-30	80	38	22370.0312
8	15	9.5	39.2	18.4	8.2	33.3	13.4	8	38	-30	80	37	22370.0313
8	20	9.5	39.2	18.4	8.2	33.3	13.4	8	38	-30	80	39	22370.0314
8	25	9.5	39.2	18.4	8.2	33.3	13.4	8	38	-30	80	42	22370.0315
8	30	9.5	39.2	18.4	8.2	33.3	13.4	8	38	-30	80	44	22370.0316
8	35	9.5	39.2	18.4	8.2	33.3	13.4	8	38	-30	80	46	22370.0317
8	40	9.5	39.2	18.4	8.2	33.3	13.4	8	38	-30	80	47	22370.0318
8	45	9.5	39.2	18.4	8.2	33.3	13.4	8	38	-30	80	49	22370.0319
8	50	9.5	39.2	18.4	8.2	33.3	13.4	8	38	-30	80	51	22370.0320
8	60	9.5	39.2	18.4	8.2	33.3	13.4	8	38	-30	80	62	22370.0321
8	70	9.5	39.2	18.4	8.2	33.3	13.4	8	38	-30	80	65	22370.0322
8	80	9.5	39.2	18.4	8.2	33.3	13.4	8	38	-30	80	69	22370.0323
8	90	9.5	39.2	18.4	8.2	33.3	13.4	8	38	-30	80	36	22370.0311
8	100	9.5	39.2	18.4	8.2	33.3	13.4	8	38	-30	80	54	22370.0301
10	15	12.0	39.2	18.4	9.6	33.3	13.4	10	60	-30	80	86	22370.0331
10	20	12.0	39.2	18.4	9.6	33.3	13.4	10	60	-30	80	46	22370.0324
10	25	12.0	39.2	18.4	9.6	33.3	13.4	10	60	-30	80	49	22370.0325
10	30	12.0	39.2	18.4	9.6	33.3	13.4	10	60	-30	80	53	22370.0326
10	35	12.0	39.2	18.4	9.6	33.3	13.4	10	60	-30	80	55	22370.0327
10	40	12.0	39.2	18.4	9.6	33.3	13.4	10	60	-30	80	57	22370.0328
10	45	12.0	39.2	18.4	9.6	33.3	13.4	10	60	-30	80	61	22370.0329
10	50	12.0	39.2	18.4	9.6	33.3	13.4	10	60	-30	80	64	22370.0330
10	60	12.0	39.2	18.4	9.6	33.3	13.4	10	60	-30	80	70	22370.0332
10	70	12.0	39.2	18.4	9.6	33.3	13.4	10	60	-30	80	91	22370.0333
10	80	12.0	39.2	18.4	9.6	33.3	13.4	10	60	-30	80	97	22370.0334
10	90	12.0	39.2	18.4	9.6	33.3	13.4	10	60	-30	80	103	22370.0335
10	100	12.0	39.2	18.4	9.6	33.3	13.4	10	60	-30	80	109	22370.0336
10	110	12.0	39.2	18.4	9.6	33.3	13.4	10	60	-30	80	115	22370.0337
10	120	12.0	39.2	18.4	9.6	33.3	13.4	10	60	-30	80	53	22370.0338
12	20	14.5	47.6	25.2	10.6	39.7	16.7	12	87	-30	80	91	22370.0344
12	25	14.5	47.6	25.2	10.6	39.7	16.7	12	87	-30	80	96	22370.0345
12	30	14.5	47.6	25.2	10.6	39.7	16.7	12	87	-30	80	100	22370.0346
12	35	14.5	47.6	25.2	10.6	39.7	16.7	12	87	-30	80	105	22370.0347
12	40	14.5	47.6	25.2	10.6	39.7	16.7	12	87	-30	80	109	22370.0348
12	45	14.5	47.6	25.2	10.6	39.7	16.7	12	87	-30	80	113	22370.0349
12	50	14.5	47.6	25.2	10.6	39.7	16.7	12	87	-30	80	117	22370.0350
12	60	14.5	47.6	25.2	10.6	39.7	16.7	12	87	-30	80	126	22370.0352
12	70	14.5	47.6	25.2	10.6	39.7	16.7	12	87	-30	80	134	22370.0354
12	80	14.5	47.6	25.2	10.6	39.7	16.7	12	87	-30	80	143	22370.0356
12	90	14.5	47.6	25.2	10.6	39.7	16.7	12	87	-30	80	165	22370.0357
12	100	14.5	47.6	25.2	10.6	39.7	16.7	12	87	-30	80	173	22370.0358
12	110	14.5	47.6	25.2	10.6	39.7	16.7	12	87	-30	80	182	22370.0359
12	120	14.5	47.6	25.2	10.6	39.7	16.7	12	87	-30	80	177	22370.0360
16	30	19.0	47.6	25.2	14.0	39.7	16.7	16	155	-30	80	132	22370.0366
16	35	19.0	47.6	25.2	14.0	39.7	16.7	16	155	-30	80	140	22370.0367
16	40	19.0	47.6	25.2	14.0	39.7	16.7	16	155	-30	80	148	22370.0368
16	45	19.0	47.6	25.2	14.0	39.7	16.7	16	155	-30	80	155	22370.0369
16	50	19.0	47.6	25.2	14.0	39.7	16.7	16	155	-30	80	168	22370.0370
16	60	19.0	47.6	25.2	14.0	39.7	16.7	16	155	-30	80	178	22370.0372
16	70	19.0	47.6	25.2	14.0	39.7	16.7	16	155	-30	80	194	22370.0374
16	80	19.0	47.6	25.2	14.0	39.7	16.7	16	155	-30	80	208	22370.0376
16	90	19.0	47.6	25.2	14.0	39.7	16.7	16	155	-30	80	234	22370.0377
16	100	19.0	47.6	25.2	14.0	39.7	16.7	16	155	-30	80	251	22370.0378



¹⁾ Shearing resistance similar to DIN 50141

d ₁ -0.04 -0.08	l ₁ +0.6	Dimensions						Location hole H11 [mm]	Shearing resistance, two-shear ¹⁾ min. [kN]	 min. max. [°C]		 [g]	Art. No.
		d ₂	d ₃	d ₄	l ₂ ±1	l ₃	l ₄						
16	110	19.0	47.6	25.2	14.0	39.7	16.7	16	155	-30	80	266	22370.0379
16	120	19.0	47.6	25.2	14.0	39.7	16.7	16	155	-30	80	281	22370.0380
16	130	19.0	47.6	25.2	14.0	39.7	16.7	16	155	-30	80	297	22370.0381
16	140	19.0	47.6	25.2	14.0	39.7	16.7	16	155	-30	80	313	22370.0382
16	150	19.0	47.6	25.2	14.0	39.7	16.7	16	155	-30	80	328	22370.0383
20	50	25.0	57.1	33.8	20.5	50.7	21.5	20	244	-30	80	329	22370.0391
20	60	25.0	57.1	33.8	20.5	50.7	21.5	20	244	-30	80	343	22370.0392
20	70	25.0	57.1	33.8	20.5	50.7	21.5	20	244	-30	80	377	22370.0393
20	80	25.0	57.1	33.8	20.5	50.7	21.5	20	244	-30	80	392	22370.0396
20	90	25.0	57.1	33.8	20.5	50.7	21.5	20	244	-30	80	426	22370.0397
20	100	25.0	57.1	33.8	20.5	50.7	21.5	20	244	-30	80	444	22370.0400
20	110	25.0	57.1	33.8	20.5	50.7	21.5	20	244	-30	80	474	22370.0401
20	120	25.0	57.1	33.8	20.5	50.7	21.5	20	244	-30	80	488	22370.0404
20	130	25.0	57.1	33.8	20.5	50.7	21.5	20	244	-30	80	523	22370.0405
20	140	25.0	57.1	33.8	20.5	50.7	21.5	20	244	-30	80	546	22370.0406
20	150	25.0	57.1	33.8	20.5	50.7	21.5	20	244	-30	80	571	22370.0407
25	50	30.8	57.1	33.8	22.0	50.7	21.5	25	386	-30	80	415	22370.0409
25	60	30.8	57.1	33.8	22.0	50.7	21.5	25	386	-30	80	453	22370.0410
25	70	30.8	57.1	33.8	22.0	50.7	21.5	25	386	-30	80	503	22370.0411
25	80	30.8	57.1	33.8	22.0	50.7	21.5	25	386	-30	80	536	22370.0412
25	90	30.8	57.1	33.8	22.0	50.7	21.5	25	386	-30	80	565	22370.0413
25	100	30.8	57.1	33.8	22.0	50.7	21.5	25	386	-30	80	612	22370.0414
25	110	30.8	57.1	33.8	22.0	50.7	21.5	25	386	-30	80	640	22370.0415
25	120	30.8	57.1	33.8	22.0	50.7	21.5	25	386	-30	80	689	22370.0416
25	130	30.8	57.1	33.8	22.0	50.7	21.5	25	386	-30	80	715	22370.0417
25	140	30.8	57.1	33.8	22.0	50.7	21.5	25	386	-30	80	753	22370.0418
25	150	30.8	57.1	33.8	22.0	50.7	21.5	25	386	-30	80	811	22370.0419
Handle colour: blue													
5	10	5.5	33.2	14.5	6.0	26.7	10.8	5	14	-30	80	21	22370.0432
5	15	5.5	33.2	14.5	6.0	26.7	10.8	5	14	-30	80	15	22370.0433
5	20	5.5	33.2	14.5	6.0	26.7	10.8	5	14	-30	80	16	22370.0434
5	25	5.5	33.2	14.5	6.0	26.7	10.8	5	14	-30	80	17	22370.0435
5	30	5.5	33.2	14.5	6.0	26.7	10.8	5	14	-30	80	18	22370.0436
5	35	5.5	33.2	14.5	6.0	26.7	10.8	5	14	-30	80	19	22370.0425
5	40	5.5	33.2	14.5	6.0	26.7	10.8	5	14	-30	80	20	22370.0426
5	45	5.5	33.2	14.5	6.0	26.7	10.8	5	14	-30	80	21	22370.0427
5	50	5.5	33.2	14.5	6.0	26.7	10.8	5	14	-30	80	23	22370.0428
5	60	5.5	33.2	14.5	6.0	26.7	10.8	5	14	-30	80	21	22370.0429
5	70	5.5	33.2	14.5	6.0	26.7	10.8	5	14	-30	80	18	22370.0430
5	80	5.5	33.2	14.5	6.0	26.7	10.8	5	14	-30	80	19	22370.0431
6	10	7.0	33.2	14.5	7.0	26.7	10.8	6	21	-30	80	16	22370.0442
6	15	7.0	33.2	14.5	7.0	26.7	10.8	6	21	-30	80	17	22370.0443
6	20	7.0	33.2	14.5	7.0	26.7	10.8	6	21	-30	80	18	22370.0444
6	25	7.0	33.2	14.5	7.0	26.7	10.8	6	21	-30	80	19	22370.0445
6	30	7.0	33.2	14.5	7.0	26.7	10.8	6	21	-30	80	20	22370.0446
6	35	7.0	33.2	14.5	7.0	26.7	10.8	6	21	-30	80	21	22370.0447
6	40	7.0	33.2	14.5	7.0	26.7	10.8	6	21	-30	80	22	22370.0448
6	45	7.0	33.2	14.5	7.0	26.7	10.8	6	21	-30	80	23	22370.0449
6	50	7.0	33.2	14.5	7.0	26.7	10.8	6	21	-30	80	24	22370.0450
6	60	7.0	33.2	14.5	7.0	26.7	10.8	6	21	-30	80	26	22370.0437
6	70	7.0	33.2	14.5	7.0	26.7	10.8	6	21	-30	80	28	22370.0438
6	80	7.0	33.2	14.5	7.0	26.7	10.8	6	21	-30	80	30	22370.0439
8	10	9.5	39.2	18.4	8.2	33.3	13.4	8	38	-30	80	38	22370.0452
8	15	9.5	39.2	18.4	8.2	33.3	13.4	8	38	-30	80	37	22370.0453
8	20	9.5	39.2	18.4	8.2	33.3	13.4	8	38	-30	80	39	22370.0454
8	25	9.5	39.2	18.4	8.2	33.3	13.4	8	38	-30	80	42	22370.0455
8	30	9.5	39.2	18.4	8.2	33.3	13.4	8	38	-30	80	44	22370.0456
8	35	9.5	39.2	18.4	8.2	33.3	13.4	8	38	-30	80	46	22370.0457



¹⁾ Shearing resistance similar to DIN 50141

d ₁ -0.04 -0.08	l ₁ +0.6	Dimensions						Location hole H11 [mm]	Shearing resistance, two-shear ¹⁾ min. [kN]	 min. max. [°C]		 [g]	Art. No.
		d ₂	d ₃	d ₄	l ₂ ±1	l ₃	l ₄			[°C]			
8	40	9.5	39.2	18.4	8.2	33.3	13.4	8	38	-30	80	47	22370.0458
8	45	9.5	39.2	18.4	8.2	33.3	13.4	8	38	-30	80	49	22370.0459
8	50	9.5	39.2	18.4	8.2	33.3	13.4	8	38	-30	80	51	22370.0460
8	60	9.5	39.2	18.4	8.2	33.3	13.4	8	38	-30	80	62	22370.0461
8	70	9.5	39.2	18.4	8.2	33.3	13.4	8	38	-30	80	65	22370.0462
8	80	9.5	39.2	18.4	8.2	33.3	13.4	8	38	-30	80	69	22370.0463
8	90	9.5	39.2	18.4	8.2	33.3	13.4	8	38	-30	80	36	22370.0451
8	100	9.5	39.2	18.4	8.2	33.3	13.4	8	38	-30	80	54	22370.0441
10	15	12.0	39.2	18.4	9.6	33.3	13.4	10	60	-30	80	86	22370.0471
10	20	12.0	39.2	18.4	9.6	33.3	13.4	10	60	-30	80	46	22370.0464
10	25	12.0	39.2	18.4	9.6	33.3	13.4	10	60	-30	80	49	22370.0465
10	30	12.0	39.2	18.4	9.6	33.3	13.4	10	60	-30	80	53	22370.0466
10	35	12.0	39.2	18.4	9.6	33.3	13.4	10	60	-30	80	55	22370.0467
10	40	12.0	39.2	18.4	9.6	33.3	13.4	10	60	-30	80	57	22370.0468
10	45	12.0	39.2	18.4	9.6	33.3	13.4	10	60	-30	80	61	22370.0469
10	50	12.0	39.2	18.4	9.6	33.3	13.4	10	60	-30	80	64	22370.0470
10	60	12.0	39.2	18.4	9.6	33.3	13.4	10	60	-30	80	70	22370.0472
10	70	12.0	39.2	18.4	9.6	33.3	13.4	10	60	-30	80	91	22370.0473
10	80	12.0	39.2	18.4	9.6	33.3	13.4	10	60	-30	80	97	22370.0474
10	90	12.0	39.2	18.4	9.6	33.3	13.4	10	60	-30	80	103	22370.0475
10	100	12.0	39.2	18.4	9.6	33.3	13.4	10	60	-30	80	109	22370.0476
10	110	12.0	39.2	18.4	9.6	33.3	13.4	10	60	-30	80	115	22370.0477
10	120	12.0	39.2	18.4	9.6	33.3	13.4	10	60	-30	80	53	22370.0478
12	20	14.5	47.6	25.2	10.6	39.7	16.7	12	87	-30	80	91	22370.0484
12	25	14.5	47.6	25.2	10.6	39.7	16.7	12	87	-30	80	96	22370.0485
12	30	14.5	47.6	25.2	10.6	39.7	16.7	12	87	-30	80	100	22370.0486
12	35	14.5	47.6	25.2	10.6	39.7	16.7	12	87	-30	80	105	22370.0487
12	40	14.5	47.6	25.2	10.6	39.7	16.7	12	87	-30	80	109	22370.0488
12	45	14.5	47.6	25.2	10.6	39.7	16.7	12	87	-30	80	113	22370.0489
12	50	14.5	47.6	25.2	10.6	39.7	16.7	12	87	-30	80	117	22370.0490
12	60	14.5	47.6	25.2	10.6	39.7	16.7	12	87	-30	80	126	22370.0492
12	70	14.5	47.6	25.2	10.6	39.7	16.7	12	87	-30	80	134	22370.0494
12	80	14.5	47.6	25.2	10.6	39.7	16.7	12	87	-30	80	143	22370.0496
12	90	14.5	47.6	25.2	10.6	39.7	16.7	12	87	-30	80	165	22370.0497
12	100	14.5	47.6	25.2	10.6	39.7	16.7	12	87	-30	80	173	22370.0498
12	110	14.5	47.6	25.2	10.6	39.7	16.7	12	87	-30	80	182	22370.0499
12	120	14.5	47.6	25.2	10.6	39.7	16.7	12	87	-30	80	177	22370.0500
16	30	19.0	47.6	25.2	14.0	39.7	16.7	16	155	-30	80	132	22370.0506
16	35	19.0	47.6	25.2	14.0	39.7	16.7	16	155	-30	80	140	22370.0507
16	40	19.0	47.6	25.2	14.0	39.7	16.7	16	155	-30	80	148	22370.0508
16	45	19.0	47.6	25.2	14.0	39.7	16.7	16	155	-30	80	155	22370.0509
16	50	19.0	47.6	25.2	14.0	39.7	16.7	16	155	-30	80	168	22370.0510
16	60	19.0	47.6	25.2	14.0	39.7	16.7	16	155	-30	80	178	22370.0512
16	70	19.0	47.6	25.2	14.0	39.7	16.7	16	155	-30	80	194	22370.0514
16	80	19.0	47.6	25.2	14.0	39.7	16.7	16	155	-30	80	208	22370.0516
16	90	19.0	47.6	25.2	14.0	39.7	16.7	16	155	-30	80	234	22370.0517
16	100	19.0	47.6	25.2	14.0	39.7	16.7	16	155	-30	80	251	22370.0518
16	110	19.0	47.6	25.2	14.0	39.7	16.7	16	155	-30	80	266	22370.0519
16	120	19.0	47.6	25.2	14.0	39.7	16.7	16	155	-30	80	281	22370.0520
16	130	19.0	47.6	25.2	14.0	39.7	16.7	16	155	-30	80	297	22370.0521
16	140	19.0	47.6	25.2	14.0	39.7	16.7	16	155	-30	80	313	22370.0522
16	150	19.0	47.6	25.2	14.0	39.7	16.7	16	155	-30	80	328	22370.0523
20	50	25.0	57.1	33.8	20.5	50.7	21.5	20	244	-30	80	329	22370.0531
20	60	25.0	57.1	33.8	20.5	50.7	21.5	20	244	-30	80	343	22370.0532
20	70	25.0	57.1	33.8	20.5	50.7	21.5	20	244	-30	80	377	22370.0533
20	80	25.0	57.1	33.8	20.5	50.7	21.5	20	244	-30	80	392	22370.0536
20	90	25.0	57.1	33.8	20.5	50.7	21.5	20	244	-30	80	426	22370.0537
20	100	25.0	57.1	33.8	20.5	50.7	21.5	20	244	-30	80	444	22370.0540
20	110	25.0	57.1	33.8	20.5	50.7	21.5	20	244	-30	80	474	22370.0541

¹⁾ Shearing resistance similar to DIN 50141

d ₁ -0.04 -0.08	l ₁ +0.6	Dimensions						Location hole H11 [mm]	Shearing resistance, two-shear ¹⁾ min. [kN]	 min. max.		 [g]	Art. No.
		d ₂	d ₃	d ₄	l ₂ ±1	l ₃	l ₄			[°C]			
		[mm]								[°C]			
20	120	25.0	57.1	33.8	20.5	50.7	21.5	20	244	-30	80	488	22370.0544
20	130	25.0	57.1	33.8	20.5	50.7	21.5	20	244	-30	80	523	22370.0545
20	140	25.0	57.1	33.8	20.5	50.7	21.5	20	244	-30	80	546	22370.0546
20	150	25.0	57.1	33.8	20.5	50.7	21.5	20	244	-30	80	571	22370.0547
25	50	30.8	57.1	33.8	22.0	50.7	21.5	25	386	-30	80	415	22370.0549
25	60	30.8	57.1	33.8	22.0	50.7	21.5	25	386	-30	80	453	22370.0550
25	70	30.8	57.1	33.8	22.0	50.7	21.5	25	386	-30	80	503	22370.0551
25	80	30.8	57.1	33.8	22.0	50.7	21.5	25	386	-30	80	536	22370.0552
25	90	30.8	57.1	33.8	22.0	50.7	21.5	25	386	-30	80	565	22370.0553
25	100	30.8	57.1	33.8	22.0	50.7	21.5	25	386	-30	80	612	22370.0554
25	110	30.8	57.1	33.8	22.0	50.7	21.5	25	386	-30	80	640	22370.0555
25	120	30.8	57.1	33.8	22.0	50.7	21.5	25	386	-30	80	689	22370.0556
25	130	30.8	57.1	33.8	22.0	50.7	21.5	25	386	-30	80	715	22370.0557
25	140	30.8	57.1	33.8	22.0	50.7	21.5	25	386	-30	80	753	22370.0558
25	150	30.8	57.1	33.8	22.0	50.7	21.5	25	386	-30	80	811	22370.0559
Handle colour: black													
5	10	5.5	33.2	14.5	6.0	26.7	10.8	5	14	-30	80	21	22370.0812
5	15	5.5	33.2	14.5	6.0	26.7	10.8	5	14	-30	80	15	22370.0813
5	20	5.5	33.2	14.5	6.0	26.7	10.8	5	14	-30	80	16	22370.0814
5	25	5.5	33.2	14.5	6.0	26.7	10.8	5	14	-30	80	17	22370.0815
5	30	5.5	33.2	14.5	6.0	26.7	10.8	5	14	-30	80	18	22370.0816
5	35	5.5	33.2	14.5	6.0	26.7	10.8	5	14	-30	80	19	22370.0805
5	40	5.5	33.2	14.5	6.0	26.7	10.8	5	14	-30	80	20	22370.0806
5	45	5.5	33.2	14.5	6.0	26.7	10.8	5	14	-30	80	21	22370.0807
5	50	5.5	33.2	14.5	6.0	26.7	10.8	5	14	-30	80	23	22370.0808
5	60	5.5	33.2	14.5	6.0	26.7	10.8	5	14	-30	80	21	22370.0809
5	70	5.5	33.2	14.5	6.0	26.7	10.8	5	14	-30	80	18	22370.0810
5	80	5.5	33.2	14.5	6.0	26.7	10.8	5	14	-30	80	19	22370.0811
6	10	7.0	33.2	14.5	7.0	26.7	10.8	6	21	-30	80	16	22370.0822
6	15	7.0	33.2	14.5	7.0	26.7	10.8	6	21	-30	80	17	22370.0823
6	20	7.0	33.2	14.5	7.0	26.7	10.8	6	21	-30	80	18	22370.0824
6	25	7.0	33.2	14.5	7.0	26.7	10.8	6	21	-30	80	19	22370.0825
6	30	7.0	33.2	14.5	7.0	26.7	10.8	6	21	-30	80	20	22370.0826
6	35	7.0	33.2	14.5	7.0	26.7	10.8	6	21	-30	80	21	22370.0827
6	40	7.0	33.2	14.5	7.0	26.7	10.8	6	21	-30	80	22	22370.0828
6	45	7.0	33.2	14.5	7.0	26.7	10.8	6	21	-30	80	23	22370.0829
6	50	7.0	33.2	14.5	7.0	26.7	10.8	6	21	-30	80	24	22370.0830
6	60	7.0	33.2	14.5	7.0	26.7	10.8	6	21	-30	80	26	22370.0817
6	70	7.0	33.2	14.5	7.0	26.7	10.8	6	21	-30	80	28	22370.0818
6	80	7.0	33.2	14.5	7.0	26.7	10.8	6	21	-30	80	30	22370.0819
8	10	9.5	39.2	18.4	8.2	33.3	13.4	8	38	-30	80	38	22370.0832
8	15	9.5	39.2	18.4	8.2	33.3	13.4	8	38	-30	80	37	22370.0833
8	20	9.5	39.2	18.4	8.2	33.3	13.4	8	38	-30	80	39	22370.0834
8	25	9.5	39.2	18.4	8.2	33.3	13.4	8	38	-30	80	42	22370.0835
8	30	9.5	39.2	18.4	8.2	33.3	13.4	8	38	-30	80	44	22370.0836
8	35	9.5	39.2	18.4	8.2	33.3	13.4	8	38	-30	80	46	22370.0837
8	40	9.5	39.2	18.4	8.2	33.3	13.4	8	38	-30	80	47	22370.0838
8	45	9.5	39.2	18.4	8.2	33.3	13.4	8	38	-30	80	49	22370.0839
8	50	9.5	39.2	18.4	8.2	33.3	13.4	8	38	-30	80	51	22370.0840
8	60	9.5	39.2	18.4	8.2	33.3	13.4	8	38	-30	80	62	22370.0841
8	70	9.5	39.2	18.4	8.2	33.3	13.4	8	38	-30	80	65	22370.0842
8	80	9.5	39.2	18.4	8.2	33.3	13.4	8	38	-30	80	69	22370.0843
8	90	9.5	39.2	18.4	8.2	33.3	13.4	8	38	-30	80	36	22370.0831
8	100	9.5	39.2	18.4	8.2	33.3	13.4	8	38	-30	80	54	22370.0821
10	15	12.0	39.2	18.4	9.6	33.3	13.4	10	60	-30	80	86	22370.0851
10	20	12.0	39.2	18.4	9.6	33.3	13.4	10	60	-30	80	46	22370.0844
10	25	12.0	39.2	18.4	9.6	33.3	13.4	10	60	-30	80	49	22370.0845
10	30	12.0	39.2	18.4	9.6	33.3	13.4	10	60	-30	80	53	22370.0846

¹⁾ Shearing resistance similar to DIN 50141

d ₁ -0.04 -0.08	l ₁ +0.6	Dimensions						Location hole H11 [mm]	Shearing resistance, two-shear ¹⁾ min. [kN]	 min. max.		 [g]	Art. No.
		d ₂	d ₃	d ₄	l ₂ ±1	l ₃	l ₄			[°C]			
		[mm]								[°C]			
10	35	12.0	39.2	18.4	9.6	33.3	13.4	10	60	-30	80	55	22370.0847
10	40	12.0	39.2	18.4	9.6	33.3	13.4	10	60	-30	80	57	22370.0848
10	45	12.0	39.2	18.4	9.6	33.3	13.4	10	60	-30	80	61	22370.0849
10	50	12.0	39.2	18.4	9.6	33.3	13.4	10	60	-30	80	64	22370.0850
10	60	12.0	39.2	18.4	9.6	33.3	13.4	10	60	-30	80	70	22370.0852
10	70	12.0	39.2	18.4	9.6	33.3	13.4	10	60	-30	80	91	22370.0853
10	80	12.0	39.2	18.4	9.6	33.3	13.4	10	60	-30	80	97	22370.0854
10	90	12.0	39.2	18.4	9.6	33.3	13.4	10	60	-30	80	103	22370.0855
10	100	12.0	39.2	18.4	9.6	33.3	13.4	10	60	-30	80	109	22370.0856
10	110	12.0	39.2	18.4	9.6	33.3	13.4	10	60	-30	80	115	22370.0857
10	120	12.0	39.2	18.4	9.6	33.3	13.4	10	60	-30	80	53	22370.0858
12	20	14.5	47.6	25.2	10.6	39.7	16.7	12	87	-30	80	91	22370.0864
12	25	14.5	47.6	25.2	10.6	39.7	16.7	12	87	-30	80	96	22370.0865
12	30	14.5	47.6	25.2	10.6	39.7	16.7	12	87	-30	80	100	22370.0866
12	35	14.5	47.6	25.2	10.6	39.7	16.7	12	87	-30	80	105	22370.0867
12	40	14.5	47.6	25.2	10.6	39.7	16.7	12	87	-30	80	109	22370.0868
12	45	14.5	47.6	25.2	10.6	39.7	16.7	12	87	-30	80	113	22370.0869
12	50	14.5	47.6	25.2	10.6	39.7	16.7	12	87	-30	80	117	22370.0870
12	60	14.5	47.6	25.2	10.6	39.7	16.7	12	87	-30	80	126	22370.0872
12	70	14.5	47.6	25.2	10.6	39.7	16.7	12	87	-30	80	134	22370.0874
12	80	14.5	47.6	25.2	10.6	39.7	16.7	12	87	-30	80	143	22370.0876
12	90	14.5	47.6	25.2	10.6	39.7	16.7	12	87	-30	80	165	22370.0877
12	100	14.5	47.6	25.2	10.6	39.7	16.7	12	87	-30	80	173	22370.0878
12	110	14.5	47.6	25.2	10.6	39.7	16.7	12	87	-30	80	182	22370.0879
12	120	14.5	47.6	25.2	10.6	39.7	16.7	12	87	-30	80	177	22370.0880
16	30	19.0	47.6	25.2	14.0	39.7	16.7	16	155	-30	80	132	22370.0886
16	35	19.0	47.6	25.2	14.0	39.7	16.7	16	155	-30	80	140	22370.0887
16	40	19.0	47.6	25.2	14.0	39.7	16.7	16	155	-30	80	148	22370.0888
16	45	19.0	47.6	25.2	14.0	39.7	16.7	16	155	-30	80	155	22370.0889
16	50	19.0	47.6	25.2	14.0	39.7	16.7	16	155	-30	80	168	22370.0890
16	60	19.0	47.6	25.2	14.0	39.7	16.7	16	155	-30	80	178	22370.0892
16	70	19.0	47.6	25.2	14.0	39.7	16.7	16	155	-30	80	194	22370.0894
16	80	19.0	47.6	25.2	14.0	39.7	16.7	16	155	-30	80	208	22370.0896
16	90	19.0	47.6	25.2	14.0	39.7	16.7	16	155	-30	80	234	22370.0897
16	100	19.0	47.6	25.2	14.0	39.7	16.7	16	155	-30	80	251	22370.0898
16	110	19.0	47.6	25.2	14.0	39.7	16.7	16	155	-30	80	266	22370.0899
16	120	19.0	47.6	25.2	14.0	39.7	16.7	16	155	-30	80	281	22370.0900
16	130	19.0	47.6	25.2	14.0	39.7	16.7	16	155	-30	80	297	22370.0901
16	140	19.0	47.6	25.2	14.0	39.7	16.7	16	155	-30	80	313	22370.0902
16	150	19.0	47.6	25.2	14.0	39.7	16.7	16	155	-30	80	328	22370.0903
20	50	25.0	57.1	33.8	20.5	50.7	21.5	20	244	-30	80	329	22370.0905
20	60	25.0	57.1	33.8	20.5	50.7	21.5	20	244	-30	80	343	22370.0904
20	70	25.0	57.1	33.8	20.5	50.7	21.5	20	244	-30	80	377	22370.0906
20	80	25.0	57.1	33.8	20.5	50.7	21.5	20	244	-30	80	392	22370.0908
20	90	25.0	57.1	33.8	20.5	50.7	21.5	20	244	-30	80	426	22370.0909
20	100	25.0	57.1	33.8	20.5	50.7	21.5	20	244	-30	80	444	22370.0912
20	110	25.0	57.1	33.8	20.5	50.7	21.5	20	244	-30	80	474	22370.0913
20	120	25.0	57.1	33.8	20.5	50.7	21.5	20	244	-30	80	488	22370.0916
20	130	25.0	57.1	33.8	20.5	50.7	21.5	20	244	-30	80	523	22370.0917
20	140	25.0	57.1	33.8	20.5	50.7	21.5	20	244	-30	80	546	22370.0918
20	150	25.0	57.1	33.8	20.5	50.7	21.5	20	244	-30	80	571	22370.0919
25	50	30.8	57.1	33.8	22.0	50.7	21.5	25	386	-30	80	415	22370.0921
25	60	30.8	57.1	33.8	22.0	50.7	21.5	25	386	-30	80	453	22370.0922
25	70	30.8	57.1	33.8	22.0	50.7	21.5	25	386	-30	80	503	22370.0923
25	80	30.8	57.1	33.8	22.0	50.7	21.5	25	386	-30	80	536	22370.0924
25	90	30.8	57.1	33.8	22.0	50.7	21.5	25	386	-30	80	565	22370.0925
25	100	30.8	57.1	33.8	22.0	50.7	21.5	25	386	-30	80	612	22370.0926
25	110	30.8	57.1	33.8	22.0	50.7	21.5	25	386	-30	80	640	22370.0927

¹⁾ Shearing resistance similar to DIN 50141

d ₁ -0.04 -0.08	l ₁ +0.6	Dimensions						Location hole H11 [mm]	Shearing resistance, two-shear ¹⁾ min. [kN]	 min. max. [°C]		 [g]	Art. No.
		d ₂	d ₃	d ₄	l ₂ ±1	l ₃	l ₄						
25	120	30.8	57.1	33.8	22.0	50.7	21.5	25	386	-30	80	689	22370.0928
25	130	30.8	57.1	33.8	22.0	50.7	21.5	25	386	-30	80	715	22370.0929
25	140	30.8	57.1	33.8	22.0	50.7	21.5	25	386	-30	80	753	22370.0930
25	150	30.8	57.1	33.8	22.0	50.7	21.5	25	386	-30	80	811	22370.0931

¹⁾ Shearing resistance similar to DIN 50141

Application example

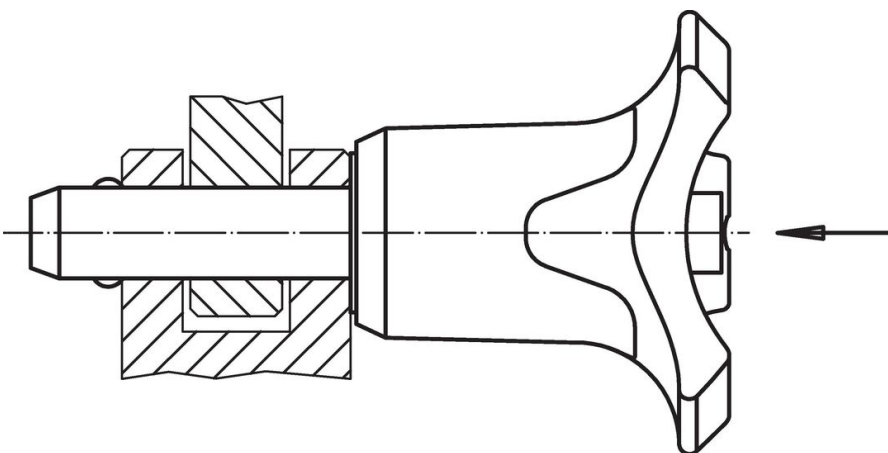

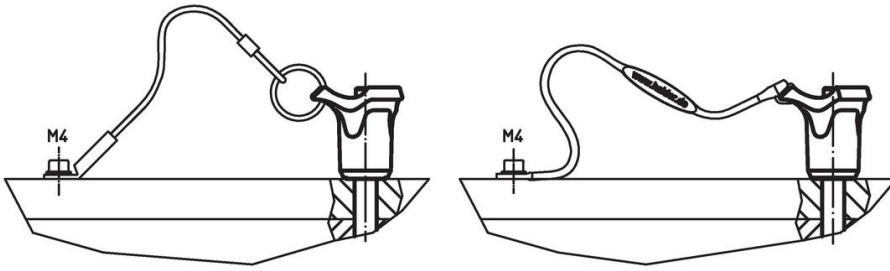

Compliance

RoHS compliant

Compliant according to Directive 2011/65/EU and Directive 2015/863.

Does not contain SVHC substances

No SVHC substances with more than 0.1% w/w contained - SVHC list [REACH] as of 23.01.2024.

Does not contain Proposition 65 substances

No Proposition 65 substances included.

<https://www.P65Warnings.ca.gov/>

Free from Conflict Minerals

This product does not contain any substances designated as "conflict minerals" such as tantalum, tin, gold or tungsten from the Democratic Republic of Congo or adjacent countries.