

Lifting Pins • self-locking, with handle

EH 22351.



Product Description

The carrying element can be used universally for transporting workpieces, workholding systems, loudspeaker boxes, containers etc. using manual force.
Lifting element with handle for quick and easy use. Special lifting supports on the workpiece, e.g. threads for screw fastening, are no longer required.
Corrosion and weathering resistant, thus also suitable for outdoor application. Very solid, precipitation-hardened pin with an extreme load capacity.

Material

Pin part

- Stainless steel 1.4542, precipitation-hardened

Handle

- Aluminium, blue anodised

Press button

- Aluminium, blue anodised

Spring

- Stainless Steel

Assembly

Simple H11 boreholes are sufficient.

Mounting:

1. Press in the button and hold it down
2. Insert the lifting pin
3. Release the button (The button must be back in its original position)

Dismantling:

1. Press in the button and hold it down.
2. Remove the lifting pin.
3. Release the button.

Operation

Each lifting pin contains an operating manual. This document is also available for download as PDF.

More information

Accessories

As accessories, we offer matching locating bushings for $d_1 = 8, 10$ and 12

Further products

- Locating Bushings, for lifting pins
- Locating Bushings, plain, for lifting pins
- Locating Bushings with Seal, plain, for lifting pins

Drawing

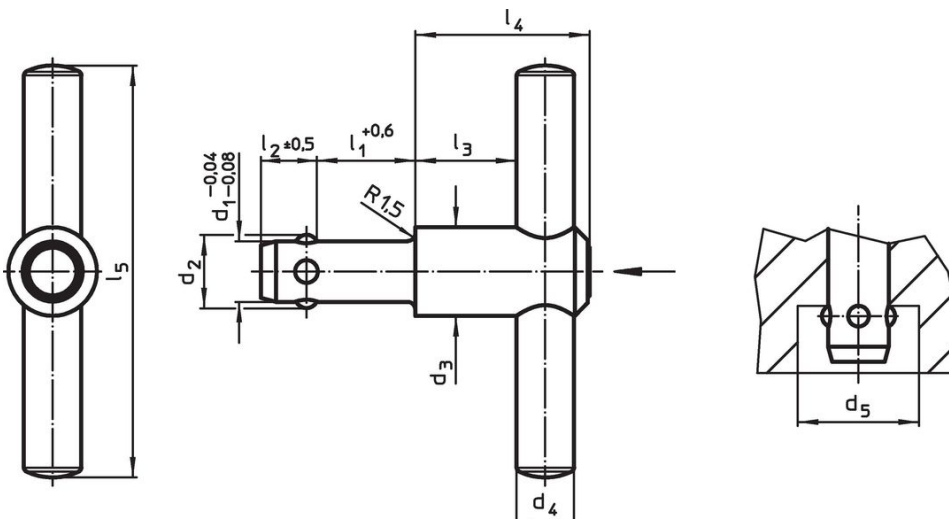

Order information

Dimensions										Load capacity	Location hole	max.		Art. No.
d ₁	l ₁	d ₂	d ₃	d ₄	d ₅	l ₂	l ₃	l ₄	l ₅	F ₁	H11			
-0.04 -0.08	+0.6				min.	±0.5				[N]	[mm]	[°C]	[g]	
[mm]														
8.0	35	9.35	21.5	14	9.85	8.75	18.7	36.0	100	500	8.0	250	136	22351.0005
8.3	35	9.65	21.5	14	10.05	8.75	18.7	36.0	100	500	8.3	250	142	22351.0010
10.0	50	11.70	21.5	14	12.20	10.20	18.7	36.5	100	500	10.0	250	154	22351.0015
12.0	50	14.20	21.5	14	14.70	11.00	18.7	36.5	100	500	12.0	250	177	22351.0020

Application example

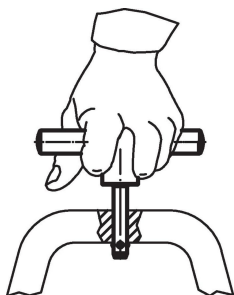

Compliance

Non-RoHS compliant

Not compliant according to Directive 2011/65/EU and Directive 2015/863.

Contains SVHC substances >0,1% w/w

Contains lead - SVHC list [REACH] as of 27.06.2024.

Contains Proposition 65 substances



Lead can cause cancer and reproductive harm from exposure
<https://www.P65Warnings.ca.gov/>

Free from Conflict Minerals

This product does not contain any substances designated as "conflict minerals" such as tantalum, tin, gold or tungsten from the Democratic Republic of Congo or adjacent countries.