

## Ball Lock Pins • self-locking, with L-handle

EH 22340. /EH 22350.



## Product Description

For quick fastening, locking, adjusting, changing and securing. Quickly and easily unlockable for frequently repeated connections.

All versions are corrosion resistant. When using stainless steel 1.4542: high-strength, hardened, abrasion resistant pin with high load capacity.

Version with ergonomic grip.

## Material

## Pin part

- Stainless steel 1.4305
- Stainless steel 1.4542, precipitation-hardened

## Handle

- Aluminium, black similar to RAL 9005

## Press button

- Stainless steel, black

## Spring

- Stainless steel

## Operation

The balls are unlocked by pressing the button.

## Characteristic

Types from stainless steel 1.4542 with marking below the balls.

## More information

## Notes

Customized design on request.

- This product is also available in INCH dimensions.

## Accessories

Can easily be fitted with retaining cable EH 22400.

## Further products

- Locating Bushings, for ball lock pins and socket pins
- Locating Bushings, with flange, for ball lock pins and socket pins
- Retaining Cables
- Positioning Bushings, with collar, DIN 172 A
- Positioning Bushings, without collar, DIN 179 A
- Ball Lock Pins with L-handle, single acting - comply with NAS / MS17986

## Drawing





\*\* Types from stainless steel 1.4542 with marking.



Order information

Dimensions										Location hole	Temperature		Weight	Shearing resistance, two-shear <sup>1)</sup>	Art. No.
d <sub>1</sub>	l <sub>1</sub>	d <sub>2</sub>	d <sub>3</sub>	l <sub>2</sub>	l <sub>3</sub>	l <sub>4</sub>	l <sub>5</sub>	l <sub>6</sub>	l <sub>7</sub>	H11	min.	max.	[g]	[kN]	
-0.04	+0.6			±1											
[mm]										[mm]	[°C]		[g]	[kN]	
Stainless steel 1.4305															
5	10	5.5	11.8	6.0	31.6	21.9	43.8	12.6	8.5	5	-30	150	20	14	22340.0112
5	15	5.5	11.8	6.0	31.6	21.9	43.8	12.6	8.5	5	-30	150	21	14	22340.0113
5	20	5.5	11.8	6.0	31.6	21.9	43.8	12.6	8.5	5	-30	150	22	14	22340.0114
5	25	5.5	11.8	6.0	31.6	21.9	43.8	12.6	8.5	5	-30	150	22	14	22340.0115
5	30	5.5	11.8	6.0	31.6	21.9	43.8	12.6	8.5	5	-30	150	23	14	22340.0116
5	35	5.5	11.8	6.0	31.6	21.9	43.8	12.6	8.5	5	-30	150	24	14	22340.0117
5	40	5.5	11.8	6.0	31.6	21.9	43.8	12.6	8.5	5	-30	150	23	14	22340.0118
5	45	5.5	11.8	6.0	31.6	21.9	43.8	12.6	8.5	5	-30	150	25	14	22340.0107
5	50	5.5	11.8	6.0	31.6	21.9	43.8	12.6	8.5	5	-30	150	26	14	22340.0108
5	60	5.5	11.8	6.0	31.6	21.9	43.8	12.6	8.5	5	-30	150	26	14	22340.0109
5	70	5.5	11.8	6.0	31.6	21.9	43.8	12.6	8.5	5	-30	150	29	14	22340.0110
5	80	5.5	11.8	6.0	31.6	21.9	43.8	12.6	8.5	5	-30	150	30	14	22340.0111
6	10	7.0	11.8	7.0	31.6	21.9	43.8	12.6	8.5	6	-30	150	21	21	22340.0122
6	15	7.0	11.8	7.0	31.6	21.9	43.8	12.6	8.5	6	-30	150	22	21	22340.0123
6	20	7.0	11.8	7.0	31.6	21.9	43.8	12.6	8.5	6	-30	150	22	21	22340.0124
6	25	7.0	11.8	7.0	31.6	21.9	43.8	12.6	8.5	6	-30	150	24	21	22340.0125
6	30	7.0	11.8	7.0	31.6	21.9	43.8	12.6	8.5	6	-30	150	25	21	22340.0126
6	35	7.0	11.8	7.0	31.6	21.9	43.8	12.6	8.5	6	-30	150	26	21	22340.0127
6	40	7.0	11.8	7.0	31.6	21.9	43.8	12.6	8.5	6	-30	150	27	21	22340.0128
6	45	7.0	11.8	7.0	31.6	21.9	43.8	12.6	8.5	6	-30	150	28	21	22340.0129
6	50	7.0	11.8	7.0	31.6	21.9	43.8	12.6	8.5	6	-30	150	29	21	22340.0130
6	60	7.0	11.8	7.0	31.6	21.9	43.8	12.6	8.5	6	-30	150	30	21	22340.0119
6	70	7.0	11.8	7.0	31.6	21.9	43.8	12.6	8.5	6	-30	150	33	21	22340.0120
6	80	7.0	11.8	7.0	31.6	21.9	43.8	12.6	8.5	6	-30	150	35	21	22340.0121
8	10	9.5	14.7	8.2	35.8	24.4	49.7	15.8	9.9	8	-30	150	34	38	22340.0132
8	15	9.5	14.7	8.2	35.8	24.4	49.7	15.8	9.9	8	-30	150	36	38	22340.0133
8	20	9.5	14.7	8.2	35.8	24.4	49.7	15.8	9.9	8	-30	150	37	38	22340.0134
8	25	9.5	14.7	8.2	35.8	24.4	49.7	15.8	9.9	8	-30	150	39	38	22340.0135
8	30	9.5	14.7	8.2	35.8	24.4	49.7	15.8	9.9	8	-30	150	41	38	22340.0136
8	35	9.5	14.7	8.2	35.8	24.4	49.7	15.8	9.9	8	-30	150	43	38	22340.0137
8	40	9.5	14.7	8.2	35.8	24.4	49.7	15.8	9.9	8	-30	150	45	38	22340.0138
8	45	9.5	14.7	8.2	35.8	24.4	49.7	15.8	9.9	8	-30	150	46	38	22340.0139
8	50	9.5	14.7	8.2	35.8	24.4	49.7	15.8	9.9	8	-30	150	48	38	22340.0140
8	60	9.5	14.7	8.2	35.8	24.4	49.7	15.8	9.9	8	-30	150	52	38	22340.0131
8	70	9.5	14.7	8.2	35.8	24.4	49.7	15.8	9.9	8	-30	150	56	38	22340.0141
8	80	9.5	14.7	8.2	35.8	24.4	49.7	15.8	9.9	8	-30	150	59	38	22340.0142
8	90	9.5	14.7	8.2	35.8	24.4	49.7	15.8	9.9	8	-30	150	63	38	22340.0143
8	100	9.5	14.7	8.2	35.8	24.4	49.7	15.8	9.9	8	-30	150	66	38	22340.0151
10	15	12.0	14.7	9.6	35.8	24.4	49.7	15.8	9.9	10	-30	150	41	60	22340.0159
10	20	12.0	14.7	9.6	35.8	24.4	49.7	15.8	9.9	10	-30	150	44	60	22340.0144
10	25	12.0	14.7	9.6	35.8	24.4	49.7	15.8	9.9	10	-30	150	47	60	22340.0145
10	30	12.0	14.7	9.6	35.8	24.4	49.7	15.8	9.9	10	-30	150	50	60	22340.0146
10	35	12.0	14.7	9.6	35.8	24.4	49.7	15.8	9.9	10	-30	150	53	60	22340.0147
10	40	12.0	14.7	9.6	35.8	24.4	49.7	15.8	9.9	10	-30	150	56	60	22340.0148
10	45	12.0	14.7	9.6	35.8	24.4	49.7	15.8	9.9	10	-30	150	58	60	22340.0149
10	50	12.0	14.7	9.6	35.8	24.4	49.7	15.8	9.9	10	-30	150	62	60	22340.0150
10	60	12.0	14.7	9.6	35.8	24.4	49.7	15.8	9.9	10	-30	150	67	60	22340.0152
10	70	12.0	14.7	9.6	35.8	24.4	49.7	15.8	9.9	10	-30	150	73	60	22340.0153
10	80	12.0	14.7	9.6	35.8	24.4	49.7	15.8	9.9	10	-30	150	79	60	22340.0154
10	90	12.0	14.7	9.6	35.8	24.4	49.7	15.8	9.9	10	-30	150	85	60	22340.0155
10	100	12.0	14.7	9.6	35.8	24.4	49.7	15.8	9.9	10	-30	150	91	60	22340.0156
10	110	12.0	14.7	9.6	35.8	24.4	49.7	15.8	9.9	10	-30	150	97	60	22340.0157
10	120	12.0	14.7	9.6	35.8	24.4	49.7	15.8	9.9	10	-30	150	103	60	22340.0158
12	20	14.5	18.2	10.6	35.1	22.7	57.1	20.2	12.6	12	-30	150	70	87	22340.0164
12	25	14.5	18.2	10.6	35.1	22.7	57.1	20.2	12.6	12	-30	150	73	87	22340.0165



<sup>1)</sup> Shearing resistance similar to DIN 50141

d <sub>1</sub> -0.04 -0.08	l <sub>1</sub> +0.6	Dimensions								Location hole H11  [mm]	 min.   max.		 [g]	Shearing resistance, two-shear <sup>1)</sup> min. [kN]	Art. No.
		d <sub>2</sub>	d <sub>3</sub>	l <sub>2</sub> ±1	l <sub>3</sub>	l <sub>4</sub>	l <sub>5</sub>	l <sub>6</sub>	l <sub>7</sub>		[°C]				
		[mm]									[°C]				
12	30	14.5	18.2	10.6	35.1	22.7	57.1	20.2	12.6	12	-30	150	78	87	22340.0166
12	35	14.5	18.2	10.6	35.1	22.7	57.1	20.2	12.6	12	-30	150	82	87	22340.0167
12	40	14.5	18.2	10.6	35.1	22.7	57.1	20.2	12.6	12	-30	150	86	87	22340.0168
12	45	14.5	18.2	10.6	35.1	22.7	57.1	20.2	12.6	12	-30	150	90	87	22340.0169
12	50	14.5	18.2	10.6	35.1	22.7	57.1	20.2	12.6	12	-30	150	94	87	22340.0170
12	60	14.5	18.2	10.6	35.1	22.7	57.1	20.2	12.6	12	-30	150	103	87	22340.0172
12	70	14.5	18.2	10.6	35.1	22.7	57.1	20.2	12.6	12	-30	150	112	87	22340.0174
12	80	14.5	18.2	10.6	35.1	22.7	57.1	20.2	12.6	12	-30	150	120	87	22340.0176
12	90	14.5	18.2	10.6	35.1	22.7	57.1	20.2	12.6	12	-30	150	129	87	22340.0160
12	100	14.5	18.2	10.6	35.1	22.7	57.1	20.2	12.6	12	-30	150	138	87	22340.0161
12	110	14.5	18.2	10.6	35.1	22.7	57.1	20.2	12.6	12	-30	150	145	87	22340.0162
12	120	14.5	18.2	10.6	35.1	22.7	57.1	20.2	12.6	12	-30	150	154	87	22340.0163
16	30	19.0	23.4	14.0	42.2	27.3	67.6	24.7	15.1	16	-30	150	149	155	22340.0171
16	35	19.0	23.4	14.0	42.2	27.3	67.6	24.7	15.1	16	-30	150	161	155	22340.0173
16	40	19.0	23.4	14.0	42.2	27.3	67.6	24.7	15.1	16	-30	150	165	155	22340.0175
16	45	19.0	23.4	14.0	42.2	27.3	67.6	24.7	15.1	16	-30	150	172	155	22340.0177
16	50	19.0	23.4	14.0	42.2	27.3	67.6	24.7	15.1	16	-30	150	180	155	22340.0178
16	60	19.0	23.4	14.0	42.2	27.3	67.6	24.7	15.1	16	-30	150	200	155	22340.0179
16	70	19.0	23.4	14.0	42.2	27.3	67.6	24.7	15.1	16	-30	150	216	155	22340.0180
16	80	19.0	23.4	14.0	42.2	27.3	67.6	24.7	15.1	16	-30	150	231	155	22340.0181
16	90	19.0	23.4	14.0	42.2	27.3	67.6	24.7	15.1	16	-30	150	246	155	22340.0182
16	100	19.0	23.4	14.0	42.2	27.3	67.6	24.7	15.1	16	-30	150	262	155	22340.0183
16	110	19.0	23.4	14.0	42.2	27.3	67.6	24.7	15.1	16	-30	150	272	155	22340.0184
16	120	19.0	23.4	14.0	42.2	27.3	67.6	24.7	15.1	16	-30	150	287	155	22340.0185
16	130	19.0	23.4	14.0	42.2	27.3	67.6	24.7	15.1	16	-30	150	302	155	22340.0186
16	140	19.0	23.4	14.0	42.2	27.3	67.6	24.7	15.1	16	-30	150	318	155	22340.0187
16	150	19.0	23.4	14.0	42.2	27.3	67.6	24.7	15.1	16	-30	150	333	155	22340.0188
20	50	24.8	23.4	17.0	43.1	27.3	67.6	24.7	15.1	20	-30	150	245	244	22340.0189
20	60	24.8	23.4	17.0	43.1	27.3	67.6	24.7	15.1	20	-30	150	272	244	22340.0190
20	70	24.8	23.4	17.0	43.1	27.3	67.6	24.7	15.1	20	-30	150	292	244	22340.0191
20	80	24.8	23.4	17.0	43.1	27.3	67.6	24.7	15.1	20	-30	150	313	244	22340.0192
20	90	24.8	23.4	17.0	43.1	27.3	67.6	24.7	15.1	20	-30	150	337	244	22340.0193
20	100	24.8	23.4	17.0	43.1	27.3	67.6	24.7	15.1	20	-30	150	362	244	22340.0194
20	110	24.8	23.4	17.0	43.1	27.3	67.6	24.7	15.1	20	-30	150	392	244	22340.0195
20	120	24.8	23.4	17.0	43.1	27.3	67.6	24.7	15.1	20	-30	150	413	244	22340.0196
20	130	24.8	23.4	17.0	43.1	27.3	67.6	24.7	15.1	20	-30	150	437	244	22340.0197
20	140	24.8	23.4	17.0	43.1	27.3	67.6	24.7	15.1	20	-30	150	457	244	22340.0198
20	150	24.8	23.4	17.0	43.1	27.3	67.6	24.7	15.1	20	-30	150	480	244	22340.0199
25	50	31.0	30.4	22.0	54.8	34.2	83.9	33.3	20.1	25	-30	150	453	386	22340.0200
25	60	31.0	30.4	22.0	54.8	34.2	83.9	33.3	20.1	25	-30	150	490	386	22340.0201
25	70	31.0	30.4	22.0	54.8	34.2	83.9	33.3	20.1	25	-30	150	523	386	22340.0202
25	80	31.0	30.4	22.0	54.8	34.2	83.9	33.3	20.1	25	-30	150	567	386	22340.0203
25	90	31.0	30.4	22.0	54.8	34.2	83.9	33.3	20.1	25	-30	150	596	386	22340.0204
25	100	31.0	30.4	22.0	54.8	34.2	83.9	33.3	20.1	25	-30	150	635	386	22340.0205
25	110	31.0	30.4	22.0	54.8	34.2	83.9	33.3	20.1	25	-30	150	672	386	22340.0206
25	120	31.0	30.4	22.0	54.8	34.2	83.9	33.3	20.1	25	-30	150	710	386	22340.0207
25	130	31.0	30.4	22.0	54.8	34.2	83.9	33.3	20.1	25	-30	150	754	386	22340.0208
25	140	31.0	30.4	22.0	54.8	34.2	83.9	33.3	20.1	25	-30	150	784	386	22340.0105
25	150	31.0	30.4	22.0	54.8	34.2	83.9	33.3	20.1	25	-30	150	830	386	22340.0106
<b>Stainless steel 1.4542, precipitation-hardened</b>															
5	10	5.5	11.8	6.0	31.6	21.9	43.8	12.6	8.5	5	-30	150	20	24	22350.0112
5	15	5.5	11.8	6.0	31.6	21.9	43.8	12.6	8.5	5	-30	150	21	24	22350.0113
5	20	5.5	11.8	6.0	31.6	21.9	43.8	12.6	8.5	5	-30	150	22	24	22350.0114
5	25	5.5	11.8	6.0	31.6	21.9	43.8	12.6	8.5	5	-30	150	22	24	22350.0115
5	30	5.5	11.8	6.0	31.6	21.9	43.8	12.6	8.5	5	-30	150	23	24	22350.0116
5	35	5.5	11.8	6.0	31.6	21.9	43.8	12.6	8.5	5	-30	150	24	24	22350.0117
5	40	5.5	11.8	6.0	31.6	21.9	43.8	12.6	8.5	5	-30	150	23	24	22350.0118
5	45	5.5	11.8	6.0	31.6	21.9	43.8	12.6	8.5	5	-30	150	25	24	22350.0107

<sup>1)</sup> Shearing resistance similar to DIN 50141

d <sub>1</sub> -0.04 -0.08	l <sub>1</sub> +0.6	Dimensions								Location hole H11  [mm]	 min.   max.		 [g]	Shearing resistance, two-shear <sup>1)</sup> min. [kN]	Art. No.
		d <sub>2</sub>	d <sub>3</sub>	l <sub>2</sub> ±1	l <sub>3</sub>	l <sub>4</sub>	l <sub>5</sub>	l <sub>6</sub>	l <sub>7</sub>		[°C]				
		[mm]									[°C]				
5	50	5.5	11.8	6.0	31.6	21.9	43.8	12.6	8.5	5	-30	150	26	24	22350.0108
5	60	5.5	11.8	6.0	31.6	21.9	43.8	12.6	8.5	5	-30	150	26	24	22350.0109
5	70	5.5	11.8	6.0	31.6	21.9	43.8	12.6	8.5	5	-30	150	29	24	22350.0110
5	80	5.5	11.8	6.0	31.6	21.9	43.8	12.6	8.5	5	-30	150	30	24	22350.0111
6	10	7.0	11.8	7.0	31.6	21.9	43.8	12.6	8.5	6	-30	150	21	35	22350.0122
6	15	7.0	11.8	7.0	31.6	21.9	43.8	12.6	8.5	6	-30	150	22	35	22350.0123
6	20	7.0	11.8	7.0	31.6	21.9	43.8	12.6	8.5	6	-30	150	22	35	22350.0124
6	25	7.0	11.8	7.0	31.6	21.9	43.8	12.6	8.5	6	-30	150	24	35	22350.0125
6	30	7.0	11.8	7.0	31.6	21.9	43.8	12.6	8.5	6	-30	150	25	35	22350.0126
6	35	7.0	11.8	7.0	31.6	21.9	43.8	12.6	8.5	6	-30	150	26	35	22350.0127
6	40	7.0	11.8	7.0	31.6	21.9	43.8	12.6	8.5	6	-30	150	27	35	22350.0128
6	45	7.0	11.8	7.0	31.6	21.9	43.8	12.6	8.5	6	-30	150	28	35	22350.0129
6	50	7.0	11.8	7.0	31.6	21.9	43.8	12.6	8.5	6	-30	150	29	35	22350.0130
6	60	7.0	11.8	7.0	31.6	21.9	43.8	12.6	8.5	6	-30	150	30	35	22350.0119
6	70	7.0	11.8	7.0	31.6	21.9	43.8	12.6	8.5	6	-30	150	33	35	22350.0120
6	80	7.0	11.8	7.0	31.6	21.9	43.8	12.6	8.5	6	-30	150	35	35	22350.0121
8	10	9.5	14.7	8.2	35.8	24.4	49.7	15.8	9.9	8	-30	150	34	63	22350.0132
8	15	9.5	14.7	8.2	35.8	24.4	49.7	15.8	9.9	8	-30	150	36	63	22350.0133
8	20	9.5	14.7	8.2	35.8	24.4	49.7	15.8	9.9	8	-30	150	37	63	22350.0134
8	25	9.5	14.7	8.2	35.8	24.4	49.7	15.8	9.9	8	-30	150	39	63	22350.0135
8	30	9.5	14.7	8.2	35.8	24.4	49.7	15.8	9.9	8	-30	150	41	63	22350.0136
8	35	9.5	14.7	8.2	35.8	24.4	49.7	15.8	9.9	8	-30	150	43	63	22350.0137
8	40	9.5	14.7	8.2	35.8	24.4	49.7	15.8	9.9	8	-30	150	45	63	22350.0138
8	45	9.5	14.7	8.2	35.8	24.4	49.7	15.8	9.9	8	-30	150	46	63	22350.0139
8	50	9.5	14.7	8.2	35.8	24.4	49.7	15.8	9.9	8	-30	150	48	63	22350.0140
8	60	9.5	14.7	8.2	35.8	24.4	49.7	15.8	9.9	8	-30	150	52	63	22350.0131
8	70	9.5	14.7	8.2	35.8	24.4	49.7	15.8	9.9	8	-30	150	56	63	22350.0141
8	80	9.5	14.7	8.2	35.8	24.4	49.7	15.8	9.9	8	-30	150	59	63	22350.0142
8	90	9.5	14.7	8.2	35.8	24.4	49.7	15.8	9.9	8	-30	150	63	63	22350.0143
8	100	9.5	14.7	8.2	35.8	24.4	49.7	15.8	9.9	8	-30	150	66	63	22350.0151
10	15	12.0	14.7	9.6	35.8	24.4	49.7	15.8	9.9	10	-30	150	41	100	22350.0159
10	20	12.0	14.7	9.6	35.8	24.4	49.7	15.8	9.9	10	-30	150	44	100	22350.0144
10	25	12.0	14.7	9.6	35.8	24.4	49.7	15.8	9.9	10	-30	150	47	100	22350.0145
10	30	12.0	14.7	9.6	35.8	24.4	49.7	15.8	9.9	10	-30	150	50	100	22350.0146
10	35	12.0	14.7	9.6	35.8	24.4	49.7	15.8	9.9	10	-30	150	53	100	22350.0147
10	40	12.0	14.7	9.6	35.8	24.4	49.7	15.8	9.9	10	-30	150	56	100	22350.0148
10	45	12.0	14.7	9.6	35.8	24.4	49.7	15.8	9.9	10	-30	150	58	100	22350.0149
10	50	12.0	14.7	9.6	35.8	24.4	49.7	15.8	9.9	10	-30	150	62	100	22350.0150
10	60	12.0	14.7	9.6	35.8	24.4	49.7	15.8	9.9	10	-30	150	67	100	22350.0152
10	70	12.0	14.7	9.6	35.8	24.4	49.7	15.8	9.9	10	-30	150	73	100	22350.0153
10	80	12.0	14.7	9.6	35.8	24.4	49.7	15.8	9.9	10	-30	150	79	100	22350.0154
10	90	12.0	14.7	9.6	35.8	24.4	49.7	15.8	9.9	10	-30	150	85	100	22350.0155
10	100	12.0	14.7	9.6	35.8	24.4	49.7	15.8	9.9	10	-30	150	91	100	22350.0156
10	110	12.0	14.7	9.6	35.8	24.4	49.7	15.8	9.9	10	-30	150	97	100	22350.0157
10	120	12.0	14.7	9.6	35.8	24.4	49.7	15.8	9.9	10	-30	150	103	100	22350.0158
12	20	14.5	18.2	10.6	35.1	22.7	57.1	20.2	12.6	12	-30	150	70	144	22350.0164
12	25	14.5	18.2	10.6	35.1	22.7	57.1	20.2	12.6	12	-30	150	73	144	22350.0165
12	30	14.5	18.2	10.6	35.1	22.7	57.1	20.2	12.6	12	-30	150	78	144	22350.0166
12	35	14.5	18.2	10.6	35.1	22.7	57.1	20.2	12.6	12	-30	150	82	144	22350.0167
12	40	14.5	18.2	10.6	35.1	22.7	57.1	20.2	12.6	12	-30	150	86	144	22350.0168
12	45	14.5	18.2	10.6	35.1	22.7	57.1	20.2	12.6	12	-30	150	90	144	22350.0169
12	50	14.5	18.2	10.6	35.1	22.7	57.1	20.2	12.6	12	-30	150	94	144	22350.0170
12	60	14.5	18.2	10.6	35.1	22.7	57.1	20.2	12.6	12	-30	150	103	144	22350.0172
12	70	14.5	18.2	10.6	35.1	22.7	57.1	20.2	12.6	12	-30	150	112	144	22350.0174
12	80	14.5	18.2	10.6	35.1	22.7	57.1	20.2	12.6	12	-30	150	120	144	22350.0176
12	90	14.5	18.2	10.6	35.1	22.7	57.1	20.2	12.6	12	-30	150	129	144	22350.0160
12	100	14.5	18.2	10.6	35.1	22.7	57.1	20.2	12.6	12	-30	150	138	144	22350.0161
12	110	14.5	18.2	10.6	35.1	22.7	57.1	20.2	12.6	12	-30	150	145	144	22350.0162
12	120	14.5	18.2	10.6	35.1	22.7	57.1	20.2	12.6	12	-30	150	154	144	22350.0163

<sup>1)</sup> Shearing resistance similar to DIN 50141

d <sub>1</sub> -0.04 -0.08	l <sub>1</sub> +0.6	d <sub>2</sub>	d <sub>3</sub>	Dimensions							Location hole H11	 min.   max.		 [g]	Shearing resistance, two-shear <sup>1)</sup> min. [kN]	Art. No.
				l <sub>2</sub> ±1	l <sub>3</sub>	l <sub>4</sub>	l <sub>5</sub>	l <sub>6</sub>	l <sub>7</sub>	[mm]		[°C]	[kN]			
16	30	19.0	23.4	14.0	42.2	27.3	67.6	24.7	15.1	16	-30	150	149	257	22350.0171	
16	35	19.0	23.4	14.0	42.2	27.3	67.6	24.7	15.1	16	-30	150	161	257	22350.0173	
16	40	19.0	23.4	14.0	42.2	27.3	67.6	24.7	15.1	16	-30	150	165	257	22350.0175	
16	45	19.0	23.4	14.0	42.2	27.3	67.6	24.7	15.1	16	-30	150	172	257	22350.0177	
16	50	19.0	23.4	14.0	42.2	27.3	67.6	24.7	15.1	16	-30	150	180	257	22350.0178	
16	60	19.0	23.4	14.0	42.2	27.3	67.6	24.7	15.1	16	-30	150	200	257	22350.0179	
16	70	19.0	23.4	14.0	42.2	27.3	67.6	24.7	15.1	16	-30	150	216	257	22350.0180	
16	80	19.0	23.4	14.0	42.2	27.3	67.6	24.7	15.1	16	-30	150	231	257	22350.0181	
16	90	19.0	23.4	14.0	42.2	27.3	67.6	24.7	15.1	16	-30	150	246	257	22350.0182	
16	100	19.0	23.4	14.0	42.2	27.3	67.6	24.7	15.1	16	-30	150	262	257	22350.0183	
16	110	19.0	23.4	14.0	42.2	27.3	67.6	24.7	15.1	16	-30	150	272	257	22350.0184	
16	120	19.0	23.4	14.0	42.2	27.3	67.6	24.7	15.1	16	-30	150	287	257	22350.0185	
16	130	19.0	23.4	14.0	42.2	27.3	67.6	24.7	15.1	16	-30	150	302	257	22350.0186	
16	140	19.0	23.4	14.0	42.2	27.3	67.6	24.7	15.1	16	-30	150	318	257	22350.0187	
16	150	19.0	23.4	14.0	42.2	27.3	67.6	24.7	15.1	16	-30	150	333	257	22350.0188	
20	50	24.8	23.4	17.0	43.1	27.3	67.6	24.7	15.1	20	-30	150	245	403	22350.0189	
20	60	24.8	23.4	17.0	43.1	27.3	67.6	24.7	15.1	20	-30	150	272	403	22350.0190	
20	70	24.8	23.4	17.0	43.1	27.3	67.6	24.7	15.1	20	-30	150	292	403	22350.0191	
20	80	24.8	23.4	17.0	43.1	27.3	67.6	24.7	15.1	20	-30	150	313	403	22350.0192	
20	90	24.8	23.4	17.0	43.1	27.3	67.6	24.7	15.1	20	-30	150	337	403	22350.0193	
20	100	24.8	23.4	17.0	43.1	27.3	67.6	24.7	15.1	20	-30	150	362	403	22350.0194	
20	110	24.8	23.4	17.0	43.1	27.3	67.6	24.7	15.1	20	-30	150	392	403	22350.0195	
20	120	24.8	23.4	17.0	43.1	27.3	67.6	24.7	15.1	20	-30	150	413	403	22350.0196	
20	130	24.8	23.4	17.0	43.1	27.3	67.6	24.7	15.1	20	-30	150	437	403	22350.0197	
20	140	24.8	23.4	17.0	43.1	27.3	67.6	24.7	15.1	20	-30	150	457	403	22350.0198	
20	150	24.8	23.4	17.0	43.1	27.3	67.6	24.7	15.1	20	-30	150	480	403	22350.0199	
25	50	31.0	30.4	22.0	54.8	34.2	83.9	33.3	20.1	25	-30	150	453	631	22350.0200	
25	60	31.0	30.4	22.0	54.8	34.2	83.9	33.3	20.1	25	-30	150	490	631	22350.0201	
25	70	31.0	30.4	22.0	54.8	34.2	83.9	33.3	20.1	25	-30	150	523	631	22350.0202	
25	80	31.0	30.4	22.0	54.8	34.2	83.9	33.3	20.1	25	-30	150	567	631	22350.0203	
25	90	31.0	30.4	22.0	54.8	34.2	83.9	33.3	20.1	25	-30	150	596	631	22350.0204	
25	100	31.0	30.4	22.0	54.8	34.2	83.9	33.3	20.1	25	-30	150	635	631	22350.0205	
25	110	31.0	30.4	22.0	54.8	34.2	83.9	33.3	20.1	25	-30	150	672	631	22350.0206	
25	120	31.0	30.4	22.0	54.8	34.2	83.9	33.3	20.1	25	-30	150	710	631	22350.0207	
25	130	31.0	30.4	22.0	54.8	34.2	83.9	33.3	20.1	25	-30	150	754	631	22350.0208	
25	140	31.0	30.4	22.0	54.8	34.2	83.9	33.3	20.1	25	-30	150	784	631	22350.0105	
25	150	31.0	30.4	22.0	54.8	34.2	83.9	33.3	20.1	25	-30	150	830	631	22350.0106	

<sup>1)</sup> Shearing resistance similar to DIN 50141

## Application example

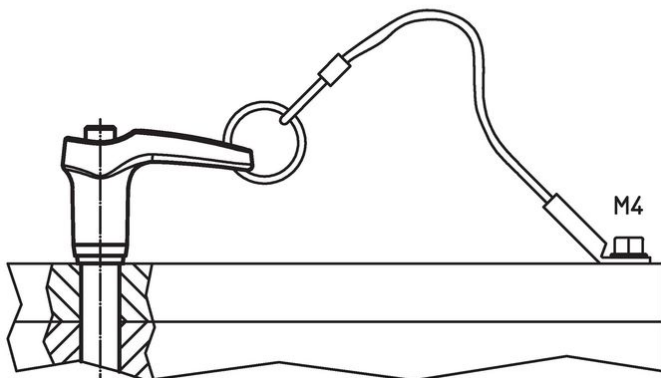
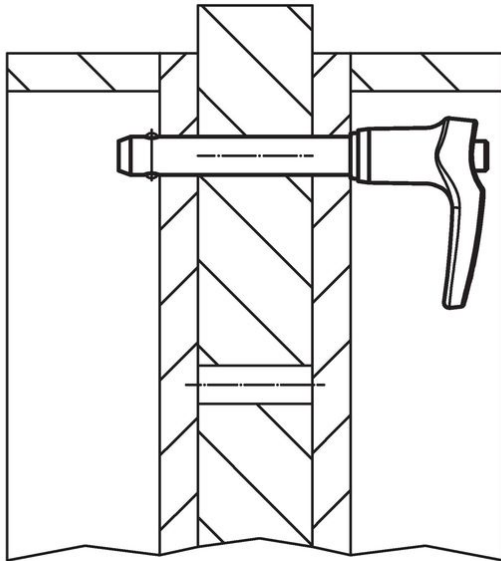

## Compliance

### RoHS compliant

Compliant according to Directive 2011/65/EU and Directive 2015/863.

### Does not contain SVHC substances

No SVHC substances with more than 0.1% w/w contained - SVHC list [REACH] as of 27.06.2024.

### Does not contain Proposition 65 substances

No Proposition 65 substances included.

<https://www.P65Warnings.ca.gov/>

### Free from Conflict Minerals

This product does not contain any substances designated as "conflict minerals" such as tantalum, tin, gold or tungsten from the Democratic Republic of Congo or adjacent countries.