

Connecting Rings

EH 1990.



Product Description

Material

- Steel, case-hardened, ground

Drawing

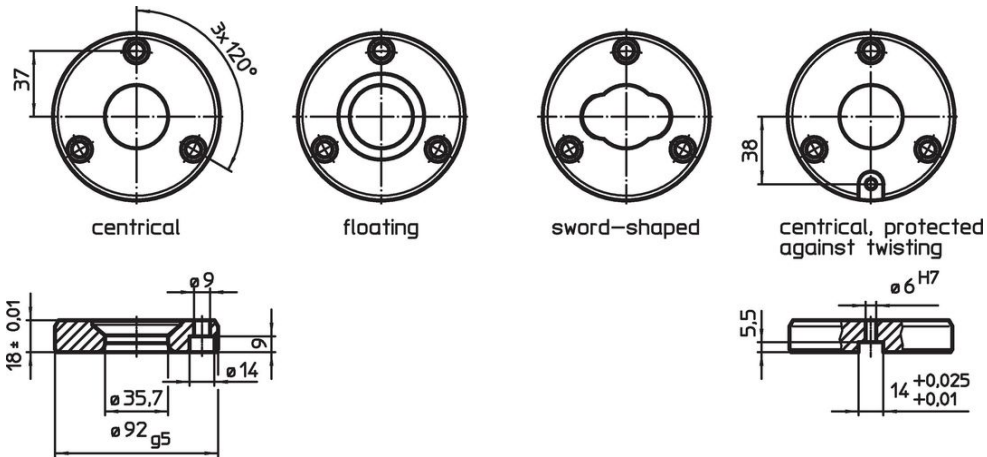

Order information

	[g]	Art. No.
central	698	1990.105
floating	728	1990.106
sword-shaped	845	1990.107
central, protected against twisting	686	1990.108

Application example

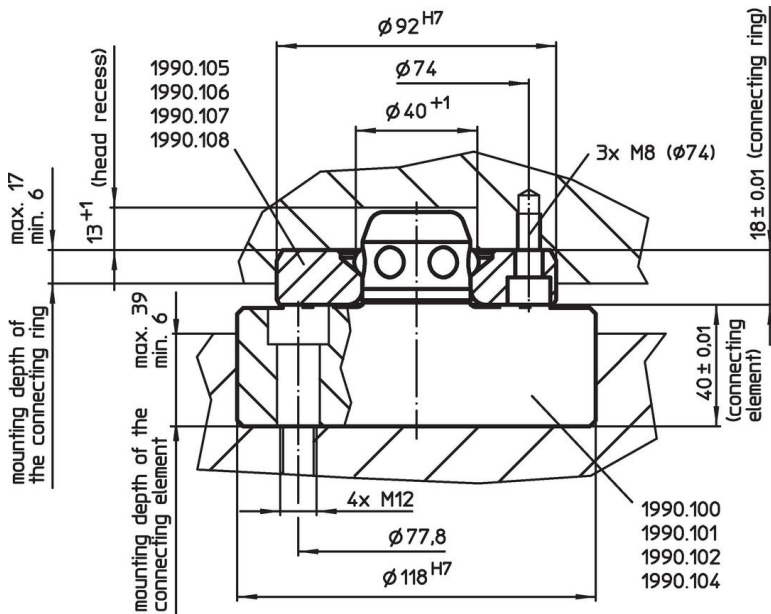
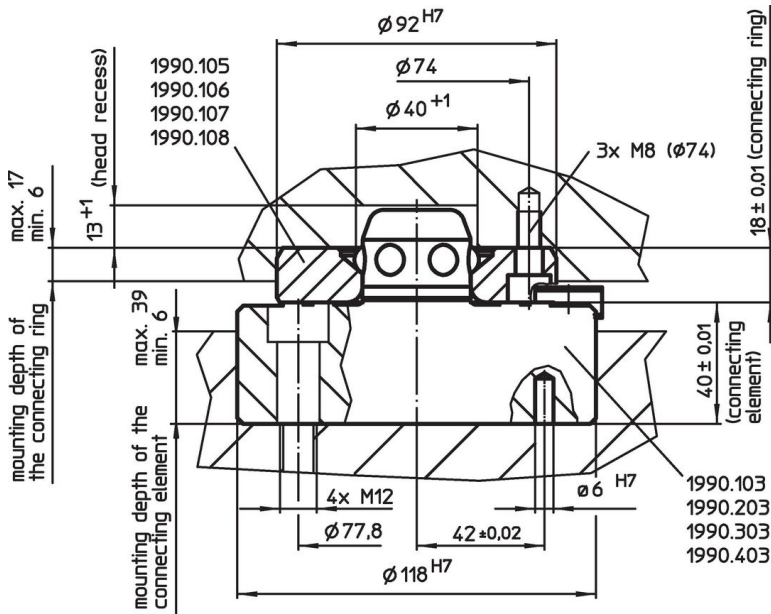

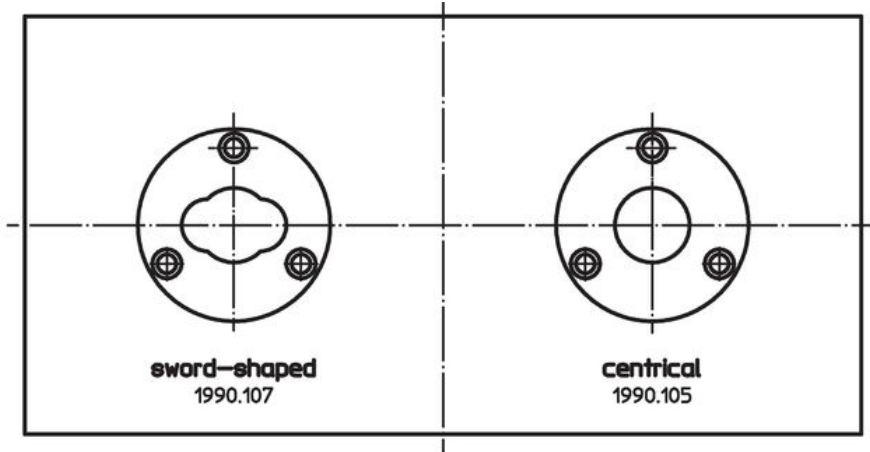

Assembly position of connecting rings independent from distance

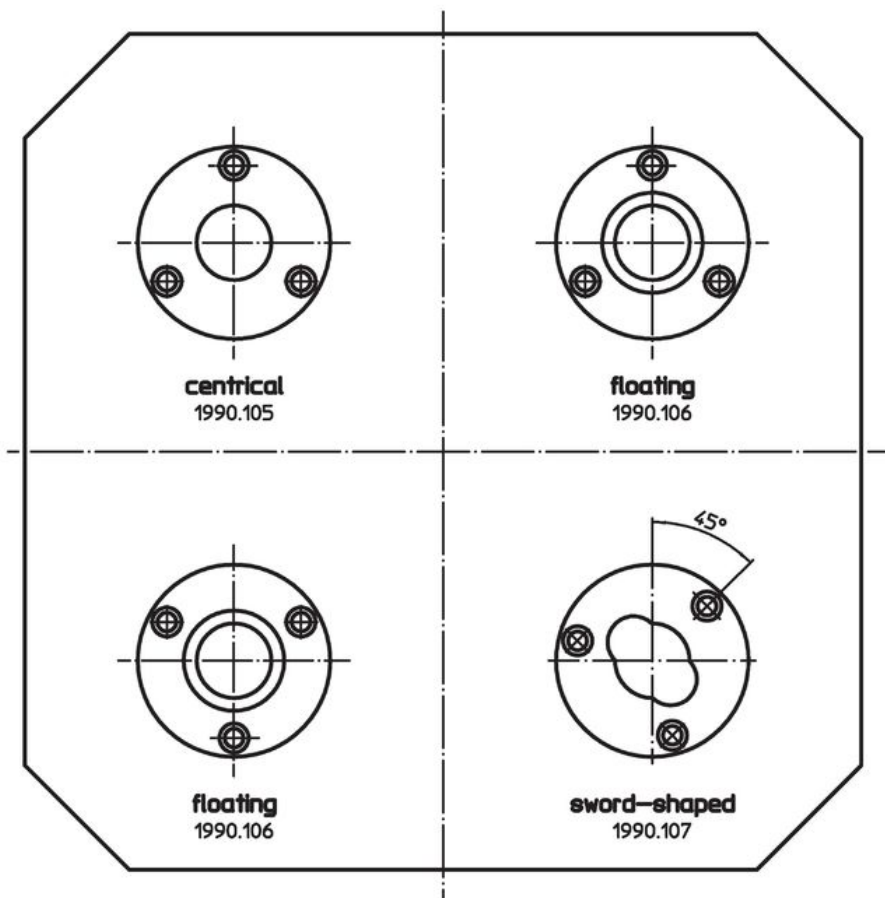

Compliance

RoHS compliant

Compliant according to Directive 2011/65/EU and Directive 2015/863.

Does not contain SVHC substances

No SVHC substances with more than 0.1% w/w contained - SVHC list [REACH] as of 23.01.2024.

Does not contain Proposition 65 substances

No Proposition 65 substances included.
<https://www.P65Warnings.ca.gov/>

Free from Conflict Minerals

This product does not contain any substances designated as "conflict minerals" such as tantalum, tin, gold or tungsten from the Democratic Republic of Congo or adjacent countries.