

Lateral Plungers • smooth, with seal - INCH
2B150.0130



Product Description

To be used for positioning and applying pressure, e.g. during painting and sandblasting. Sealed against chips and dirt.

Material

Seal

- CR

Body

- Aluminium Al

Spring

- Stainless steel

Pin

- Steel, case-hardened, zinc-plated by galvanization

Assembly

Installation by pressing in.

Formula for calculating the center distance for the mounting hole:

$$l_0 = z/2 + w + x,$$

l_0 = center distance,

y = workpiece height,

w = workpiece length,

x = coordinate dimension,

s = stroke,

z = stop diameter

Calculation dimension x :

y greater than or equal to $l_2 - d_2/2$,

then $x = d_2/2 - s$

(value x for this case see table)

or

y smaller than $l_2 - d_2/2$,

then $x = d_2/2 - s - [(l_2 - d_2/2 - y) * 0,123]$

Characteristic

Version light spring load = spring from stainless steel

More information

Further products

- Eccentric Mounting Bushings, for lateral plungers, smooth - INCH

Drawing

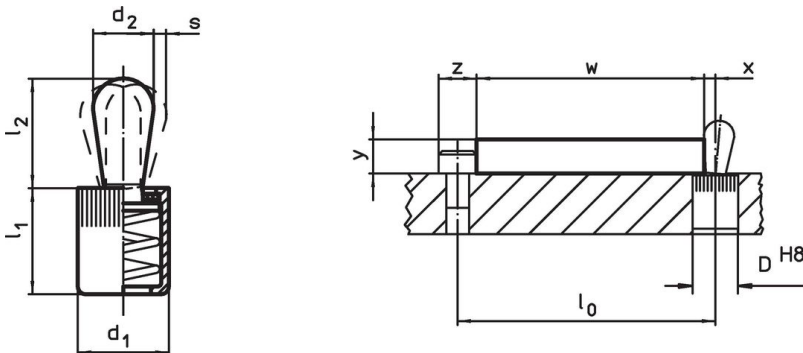



Order information

Dimensions		Spring load F max. ¹⁾ ~ [lb]	Dimensions		Stroke s [in]	Location hole D H8 [in]	x ²⁾ [in]	max. [°F]	oz	Art. No.
d_1 [in]	d_2 [in]		l_1 -0.08 [in]	l_2 [in]						
1/2	0.315	11.2	0.551	0.511	0.051	1/2	0.102	230	0.256	2B150.0130

¹⁾ statistical average value

²⁾ If the workpiece height (y) is less than $l_2 - d_2/2$, the coordinate dimension (x) must be calculated.

Accessories

	Dimensions d ₁ [in]	 [oz]	Art. No.
assembly tool			
	1/2	2.321	22150.0832

Application example



Compliance

RoHS compliant

Contains lead - compliant according to exceptions 6a / 6b / 6c.

Contains SVHC substances >0,1% w/w

Contains lead - SVHC list [REACH] as of 27.06.2024.

Contains Proposition 65 substances



Lead can cause cancer and reproductive harm from exposure
<https://www.P65Warnings.ca.gov/>

Free from Conflict Minerals

This product does not contain any substances designated as "conflict minerals" such as tantalum, tin, gold or tungsten from the Democratic Republic of Congo or adjacent countries.