

Threaded Plates • for hinges

25160.0705



Product Description

Threaded plates simplify the installation of hinges, without requiring an additional nut or washer. Counter-holding while tightening is unnecessary.

Material

- Stainless steel 1.4301, matt, vibratory ground

Drawing

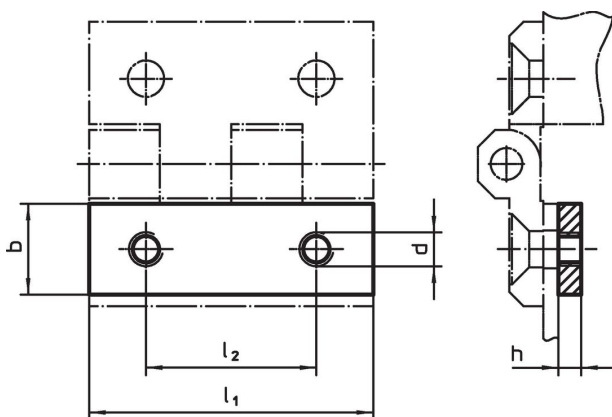

Order information

Dimensions					[g]	Art. No.
l_1	b	h [mm]	d	l_2		
30	9	3	M4	18	5.6	25160.0705

Compliance

RoHS compliant

Compliant according to Directive 2011/65/EU and Directive 2015/863.

Does not contain SVHC substances

No SVHC substances with more than 0.1% w/w contained - SVHC list [REACH] as of 27.06.2024.

Does not contain Proposition 65 substances

No Proposition 65 substances included.

<https://www.P65Warnings.ca.gov/>

Free from Conflict Minerals

This product does not contain any substances designated as "conflict minerals" such as tantalum, tin, gold or tungsten from the Democratic Republic of Congo or adjacent countries.