

Hinges • with adjustable friction resistance

25160.0400

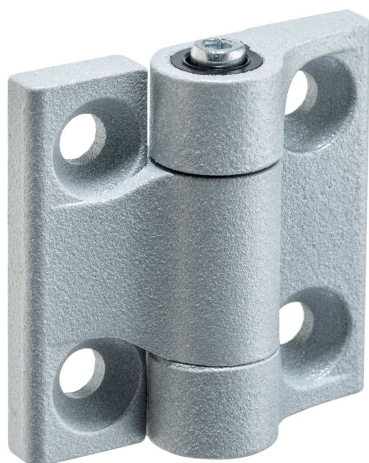

Product Description

These Hinges are characterised by their compact and stable construction, and by the ability to set the friction.

The design ensures that the hinge has no play (either radially or axially).

Material

Friction cone

- Thermoplastic POM

Body

- Zinc die-cast, plastic coated, silver, similar to RAL 9006, matt structure

Hinge pin

- Steel, zinc-plated by galvanization, passivated

Nut

- Steel, zinc-plated by galvanization, passivated

Assembly

Installation of the hinge on the component.

The hinge's ease of pivoting can then be adjusted by tightening or loosening the hinge pin. This allows a constant braking torque to be applied throughout the pivot range.

More information

Further products

- Spacer Plates, for hinges
- Threaded Plates, for hinges
- Stops, for hinges

Drawing

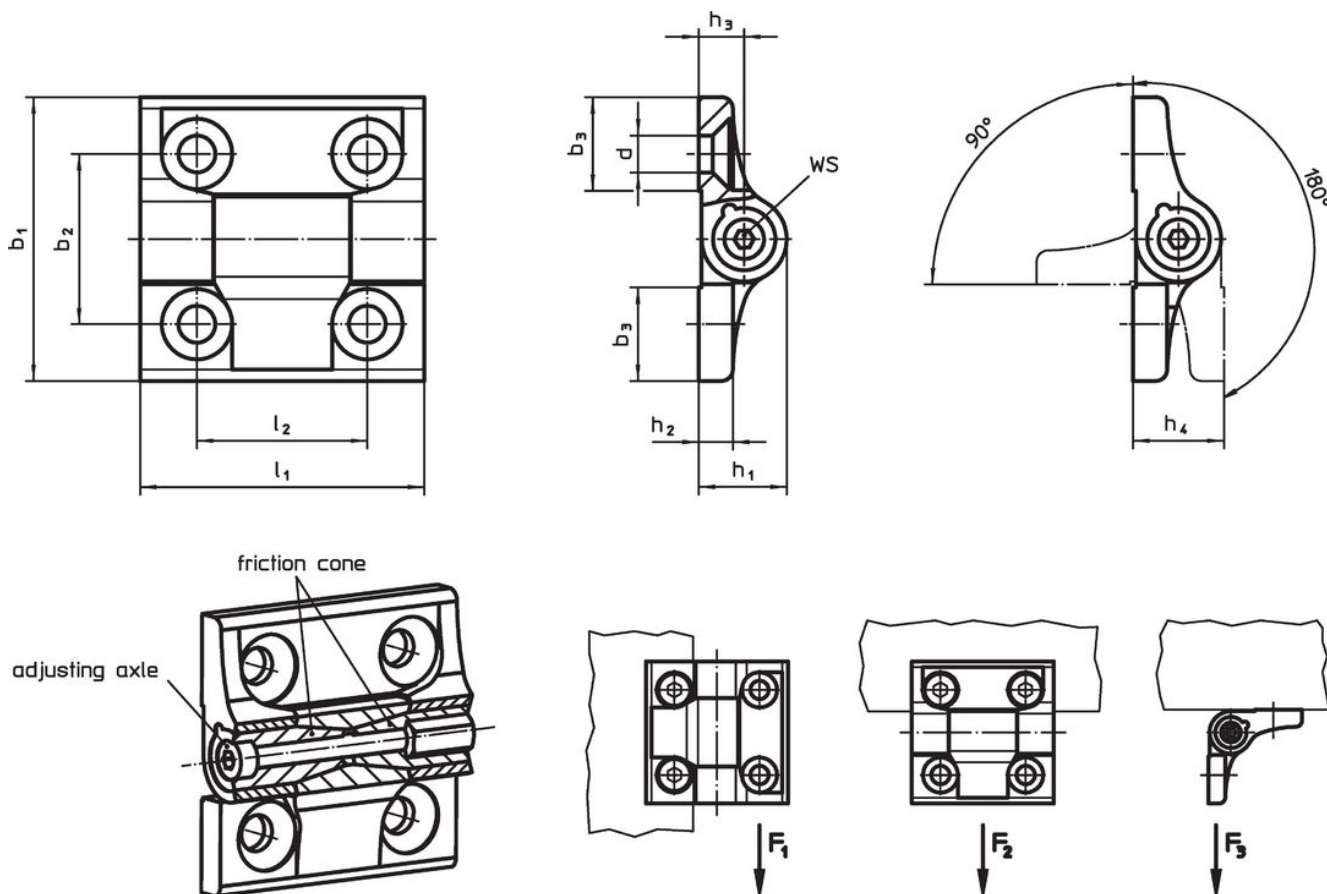

Order information

Dimensions											WS	Load capacity			Hinge pin		max.	max.	Art. No.
b ₁	b ₂	b ₃	d	h ₁	h ₂	h ₃	h ₄	l ₁	l ₂			Radial load bearing capacity F ₁ max.	Axial load bearing capacity F ₂ max.	Load capacity F ₃ max.	Tightening torque max.	Friction torque			
[mm]											[mm]	[kN]			[Nm]		[°C]	[g]	
silver																			
40	25	13	5.3	13.5	5	7	14	40	25	2.5	2.4	1.2	1.5	0.5	2	80	55	25160.0400	

Compliance

RoHS compliant

Contains lead - compliant according to exceptions 6a / 6b / 6c.

Contains SVHC substances >0,1% w/w

Contains lead - SVHC list [REACH] as of 27.06.2024.

Contains Proposition 65 substances



Lead can cause cancer and reproductive harm from exposure
<https://www.P65Warnings.ca.gov/>

Free from Conflict Minerals

This product does not contain any substances designated as "conflict minerals" such as tantalum, tin, gold or tungsten from the Democratic Republic of Congo or adjacent countries.