

Set Collars · with sensor adapter

25070.0020



Product Description

Clamping rings are provided with a fastening possibility for sensors, switches etc. Universal applicability, e.g. as a limit switch on a piston rod.
Clamping ring made of stainless steel with strong clamping force.

Material

Screw

- Stainless steel

Set collar

- Stainless steel 1.4021

Drawing

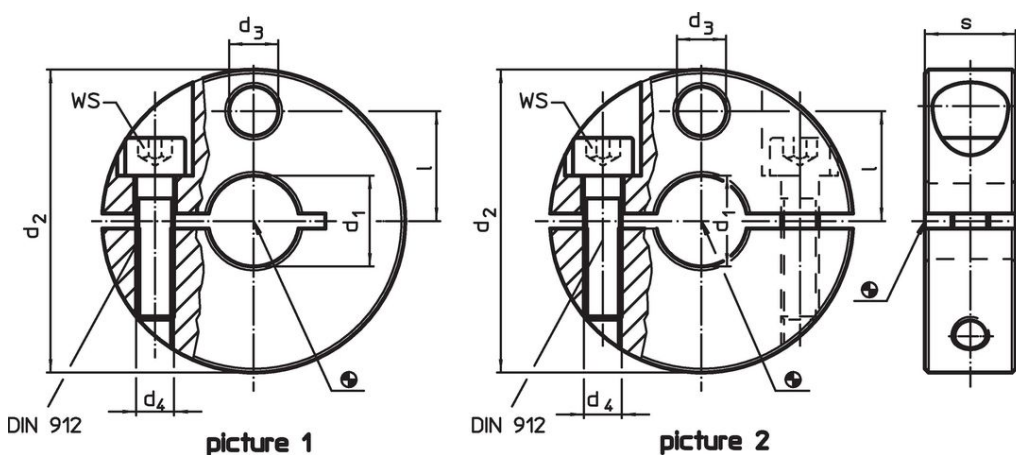

Order information

Dimensions						WS		Art. No.
d ₁	d ₂	d ₃	d ₄	l	s	[mm]	[g]	
H8	-0.5							
slotted – picture 1								
20	50	9	M6	18.5	13	5	144	25070.0020

Application example

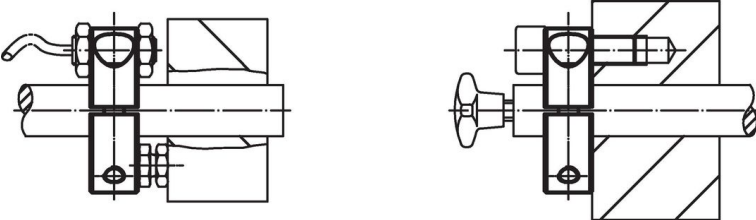

Compliance

RoHS compliant

Compliant according to Directive 2011/65/EU and Directive 2015/863.

Does not contain SVHC substances

No SVHC substances with more than 0.1% w/w contained - SVHC list [REACH] as of 23.01.2024.

Does not contain Proposition 65 substances

No Proposition 65 substances included.

<https://www.P65Warnings.ca.gov/>

Free from Conflict Minerals

This product does not contain any substances designated as "conflict minerals" such as tantalum, tin, gold or tungsten from the Democratic Republic of Congo or adjacent countries.