

## Star Grips • similar to DIN 6336, stainless steel A4

24691.1332



### Product Description

Version without dirt trap. Convenient for all applications having high hygienic requirements (e.g. food industry).  
The stainless steel A4 version ensures maximum corrosion resistance.

### Material

#### Handle

- Stainless steel 1.4408, precision casting, polished

### Drawing

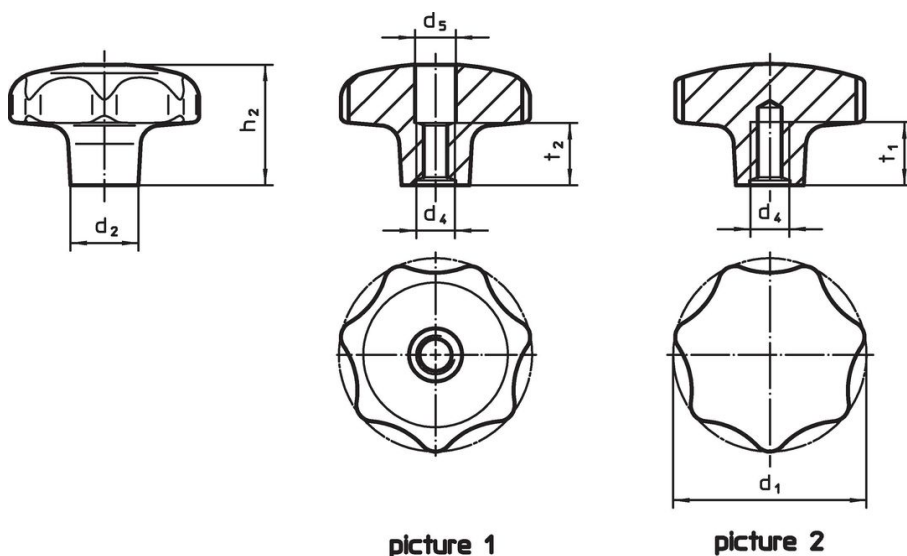

### Order information

Dimensions							[g]	Art. No.
d <sub>1</sub>	d <sub>2</sub>	d <sub>4</sub>	d <sub>5</sub>	h <sub>2</sub>	t <sub>2</sub>	[mm]		
with thread, drilled-out – picture 1								
32	12	M6	6.4	20	10		57	24691.1332

### Compliance

#### RoHS compliant

Compliant according to Directive 2011/65/EU and Directive 2015/863.

#### Does not contain SVHC substances

No SVHC substances with more than 0.1% w/w contained - SVHC list [REACH] as of 23.01.2024.

#### Does not contain Proposition 65 substances

No Proposition 65 substances included.

<https://www.P65Warnings.ca.gov/>

#### Free from Conflict Minerals

This product does not contain any substances designated as "conflict minerals" such as tantalum, tin, gold or tungsten from the Democratic Republic of Congo or adjacent countries.