

## Ball Knobs • DIN 319

24560.0032



### Product Description

The DIN 319 ball knobs are jointless and polished.

### Material

#### Bushing

- Steel, zinc-plated by galvanization

#### Ball

- Thermosetting plastic PF 31, black similar to RAL 9005

### Assembly

**Assembly instruction for form M:** Fitted by lightly tapping with a hammer, holds in position without being cemented. For the counter element a h9-fit is sufficient.

### Drawing

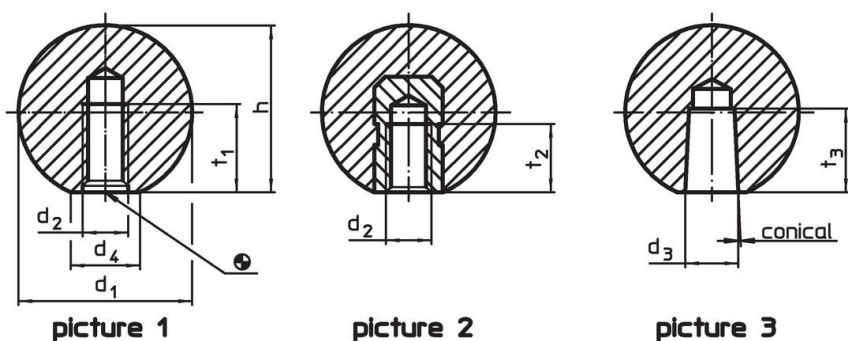

### Order information

Dimensions					🌡️	📦	Art. No.
d <sub>1</sub>	d <sub>2</sub>	d <sub>4</sub> ~ [mm]	h ~	t <sub>1</sub> min.	max. [°C]	[g]	
with moulded material thread, form C – picture 1, black							
32	M8	18	29	14	110	22	24560.0032

### Application example

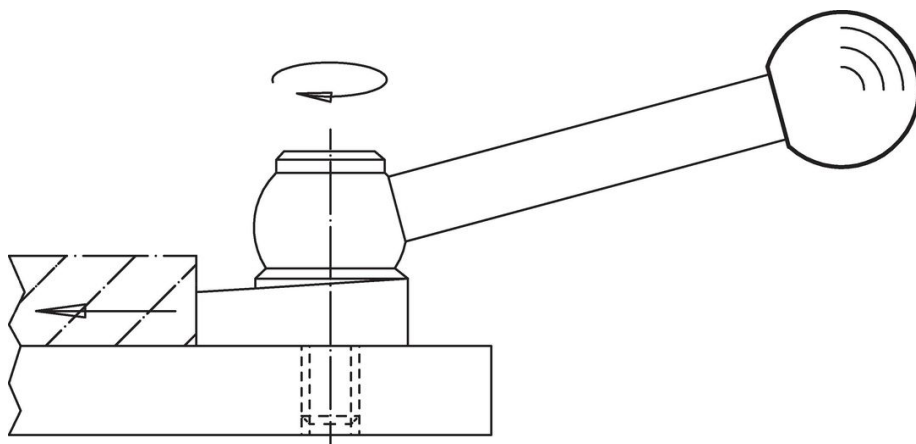

## Compliance

### RoHS compliant

Compliant according to Directive 2011/65/EU and Directive 2015/863.

### Does not contain SVHC substances

No SVHC substances with more than 0.1% w/w contained - SVHC list [REACH] as of 23.01.2024.

### Does not contain Proposition 65 substances

No Proposition 65 substances included.

<https://www.P65Warnings.ca.gov/>

### Free from Conflict Minerals

This product does not contain any substances designated as "conflict minerals" such as tantalum, tin, gold or tungsten from the Democratic Republic of Congo or adjacent countries.