

## Clamping Nuts · welded

24470.0506



### Product Description

Low-price version to DIN 99.

### Material

- Steel, zinc-plated by galvanization

### Drawing

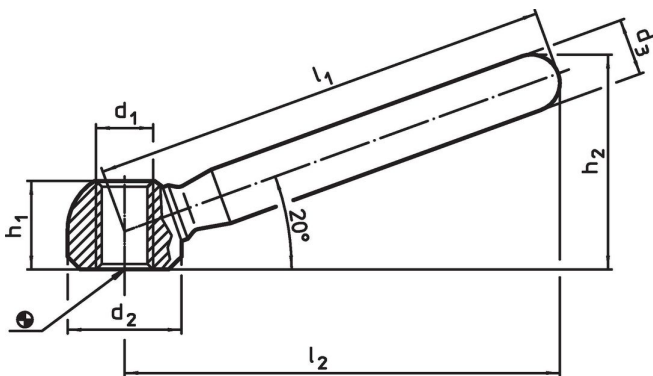

### Order information

Dimensions							[g]	Art. No.
$l_1$	$l_2$ ~	$d_1$	$d_2$	$d_3$	$h_1$	$h_2$ ~		
[mm]								
Steel								
63	60	M8	16	10	12.5	30.5	39	24470.0506

## Application example



## Compliance

### RoHS compliant

Contains lead - compliant according to exceptions 6a / 6b / 6c.

### Contains SVHC substances >0,1% w/w

Contains lead - SVHC list [REACH] as of 27.06.2024.

### Contains Proposition 65 substances



Lead can cause cancer and reproductive harm from exposure  
<https://www.P65Warnings.ca.gov/>

### Free from Conflict Minerals

This product does not contain any substances designated as "conflict minerals" such as tantalum, tin, gold or tungsten from the Democratic Republic of Congo or adjacent countries.