

Crank Handles · stainless steel precision casting

24330.0530



Product Description

Flat side of the hub is machined.

Material

Axle part

- Stainless steel 1.4301

Handle body

- Stainless steel 1.4308

Cylindrical handle

- Thermosetting plastic PF 31, black

Drawing

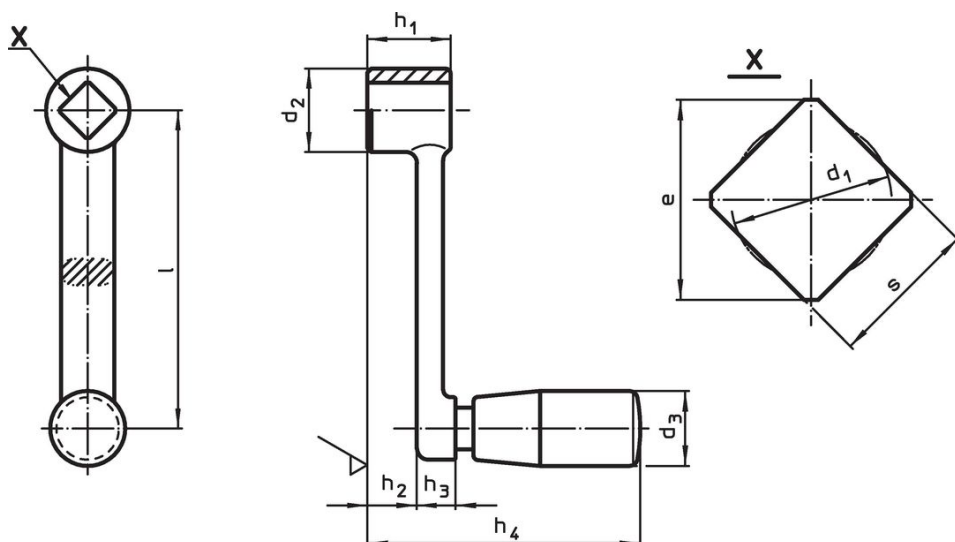

Order information

Dimensions									d <sub>3</sub>	[g]	Art. No.
l	s	e	d <sub>1</sub>	d <sub>2</sub>	h <sub>1</sub>	h <sub>2</sub>	h <sub>3</sub>	h <sub>4</sub>	Cylindrical handle Ø		
	H11	min.	max.	[mm]					EH 24530.		
100	12	16.1	12.6	26	26	17.7	8.3	78.5	21	191	24330.0530

## Application example

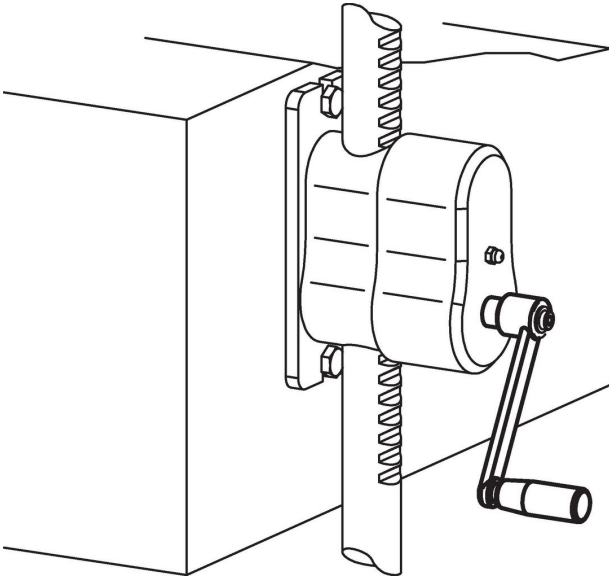

## Compliance

### RoHS compliant

Compliant according to Directive 2011/65/EU and Directive 2015/863.

### Does not contain SVHC substances

No SVHC substances with more than 0.1% w/w contained - SVHC list [REACH] as of 27.06.2024.

### Does not contain Proposition 65 substances

No Proposition 65 substances included.

<https://www.P65Warnings.ca.gov/>

### Free from Conflict Minerals

This product does not contain any substances designated as "conflict minerals" such as tantalum, tin, gold or tungsten from the Democratic Republic of Congo or adjacent countries.