

**Crank Handles · DIN 469 straight with square end DIN 79**  
24330.0121



**Product Description**

With these crank handles, the seam is ground and blasted. The hub is machined.

**Material**

**Machine handle**

- Steel, turned, zinc-plated by galvanization, passivated

**Handle body**

- Nodular cast iron, plastic coated, black

**Drawing**

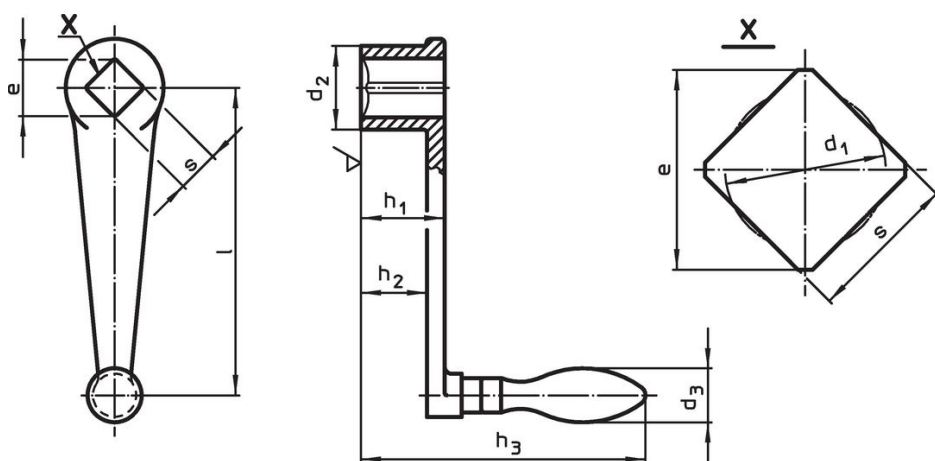

**Order information**

l	s H11	e min.	Dimensions					d <sub>3</sub> Machine handle Ø [mm]	[g]	Art. No.
			d <sub>1</sub> [mm]	d <sub>2</sub>	h <sub>1</sub>	h <sub>2</sub> ~	h <sub>3</sub>			
<b>with fixed machine handle (EH 24450., DIN 39), form F</b>										
80	12	16.1	12.6	24	24	18	94	18	186	24330.0121

**Compliance**

**RoHS compliant**

Contains lead - compliant according to exceptions 6a / 6b / 6c.

**Contains SVHC substances >0,1% w/w**

Contains lead - SVHC list [REACH] as of 23.01.2024.

**Contains Proposition 65 substances**



Lead can cause cancer and reproductive harm from exposure  
<https://www.P65Warnings.ca.gov/>

**Free from Conflict Minerals**

This product does not contain any substances designated as "conflict minerals" such as tantalum, tin, gold or tungsten from the Democratic Republic of Congo or adjacent countries.