

## Screw Jacks

23470.0010



### Product Description

Trapezoidal self-locking thread, spindle with final safety device. The holders, which can be secured by means of the T-slots, make it possible to tighten the jacks so that they will not slip out of position when a workpiece is changed. They also allow to fit screw jacks to vertical clamping surfaces. Screw jacks are frequently used for supporting workpieces. Use of the self-aligning cap ensures a correctly aligned bearing surface. Using the centering plate as an intermediate element, it is possible to fit a number of screw jacks sizes 52, 70 and 100 together one above the other.

### Material

#### Caps

- Steel, case-hardened, blackened

#### Holders

- Steel, blackened

#### Screw Jacks

- Steel 1.0503 varnished



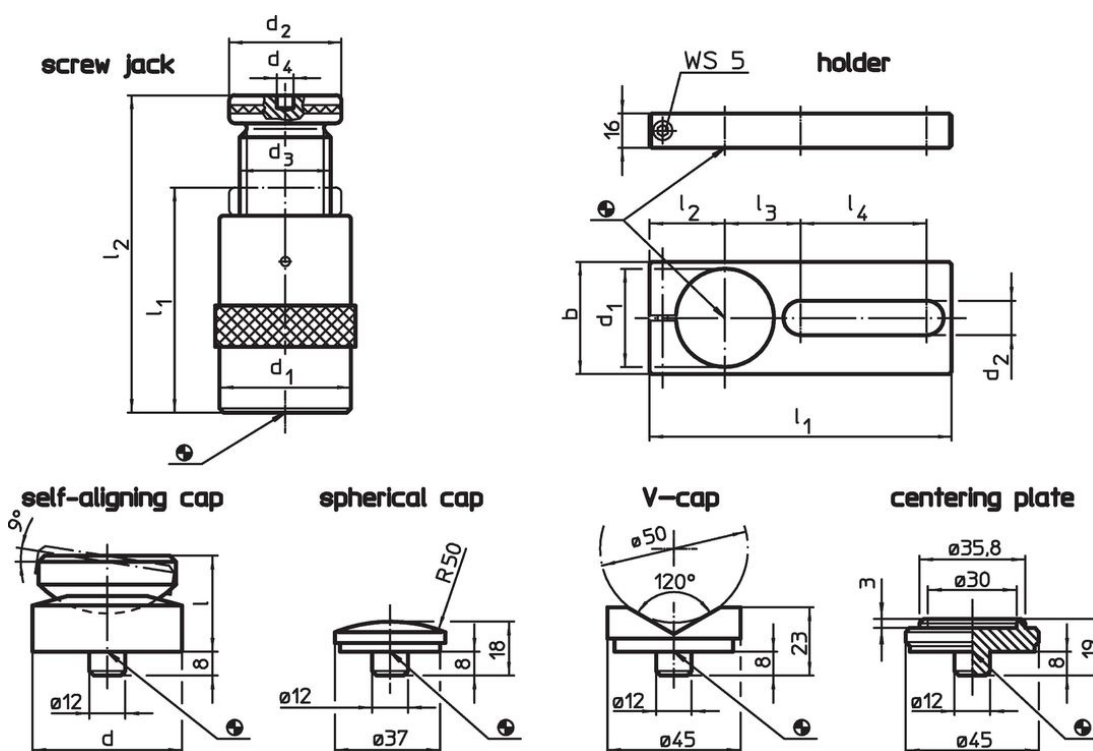



### Drawing



### Order information

l <sub>2</sub> Clamping height max. [mm]	Dimensions					Load capacity [kN]	[g]	Art. No.
	l <sub>1</sub> min.	d <sub>1</sub> [mm]	d <sub>2</sub>	d <sub>3</sub>	d <sub>4</sub> [mm]			
screw jack								
100	70	50	50	Tr 30 x 4	12	60	900	23470.0010

Accessories

	Dimensions										For screw jacks [mm]	 [g]	Art. No.
	d	d <sub>1</sub>	b	d <sub>2</sub>	l	l <sub>1</sub>	l <sub>2</sub>	l <sub>3</sub>	l <sub>4</sub>	[mm]			
<b>holder</b>													
	-	50	60	20.5	-	190	38	46	90		52/ 70/100	879	23470.0250
<b>self-aligning cap</b>													
	50	-	-	-	32	-	-	-	-		52/ 70/100	399	23470.0350
<b>spherical cap</b>													
	-	-	-	-	-	-	-	-	-		52/ 70/100/140/210/300	75	23470.0171
<b>V-cap</b>													
	-	-	-	-	-	-	-	-	-		52/ 70/100/140/210/300	138	23470.0172
<b>centering plate</b>													
	-	-	-	-	-	-	-	-	-		52/ 70/100	107	23470.0170

Compliance

**RoHS compliant**

Compliant according to Directive 2011/65/EU and Directive 2015/863.

**Does not contain SVHC substances**

No SVHC substances with more than 0.1% w/w contained - SVHC list [REACH] as of 23.01.2024.

**Does not contain Proposition 65 substances**

No Proposition 65 substances included.

<https://www.P65Warnings.ca.gov/>

**Free from Conflict Minerals**

This product does not contain any substances designated as "conflict minerals" such as tantalum, tin, gold or tungsten from the Democratic Republic of Congo or adjacent countries.