

Eccentric Clamping Modules · with shaft location

23410.0210



Product Description

The clamping effect remains unchanged and is self-locking in any angle position.

Material

- Sintered steel, case-hardened

More information

References

Possible applications in combination with e.g. gear lever handles EH 24350.

Further products

- Gear Lever Handles

Drawing

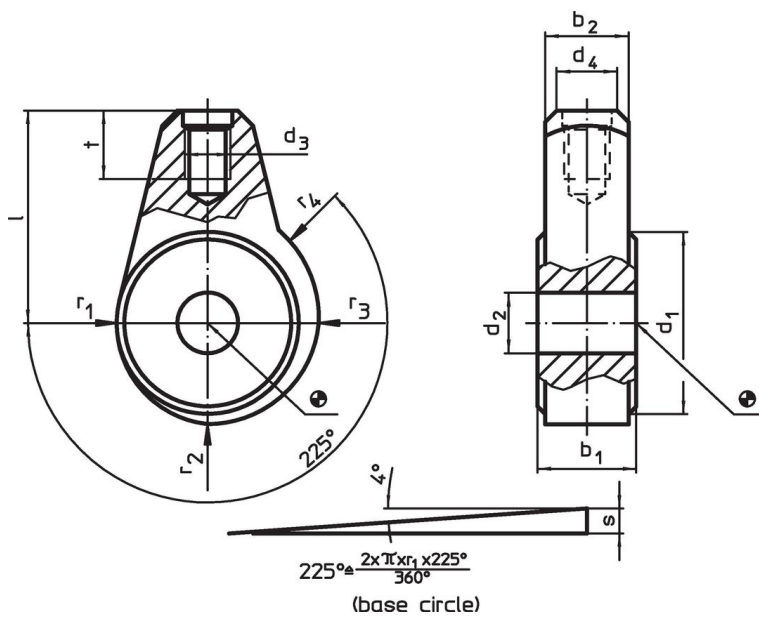

Order information

Dimensions												d ₄ Gear lever handle Ø EH 24350.		Art. No.
d ₁	d ₂ H9	b ₁ -0.05 -0.15	b ₂	d ₃	l	r ₁	r ₂	r ₃	r ₄	s	t	[mm]		
24	8	13	11	M6	28	12	13.32	14.64	15.3	3.3	9	8	50	23410.0210

Application example

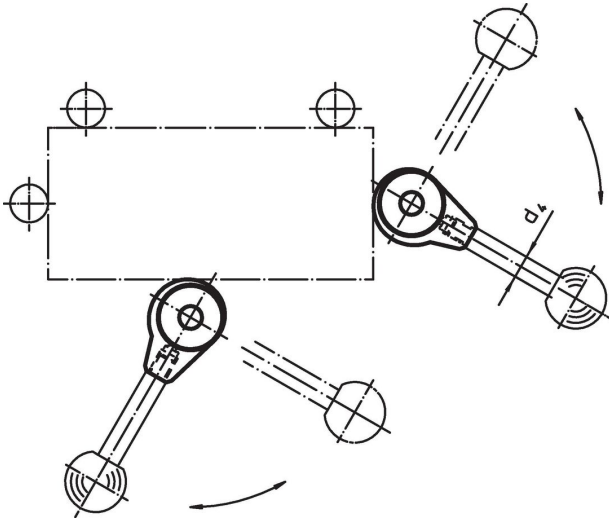

Compliance

RoHS compliant

Compliant according to Directive 2011/65/EU and Directive 2015/863.

Does not contain SVHC substances

No SVHC substances with more than 0.1% w/w contained - SVHC list [REACH] as of 23.01.2024.

Does not contain Proposition 65 substances

No Proposition 65 substances included.
<https://www.P65Warnings.ca.gov/>

Free from Conflict Minerals

This product does not contain any substances designated as "conflict minerals" such as tantalum, tin, gold or tungsten from the Democratic Republic of Congo or adjacent countries.