

Eccentric Clamping Clamps

23270.0116



Product Description

These clamps have a high clamping force for low clamping heights. The body from brass provides a gentle but safe clamping.

Material

Eccentric screw

- Steel

Body

- Brass

More information

Notes

The head of the eccentric screw can slightly protrude from the body (h_1).

Drawing

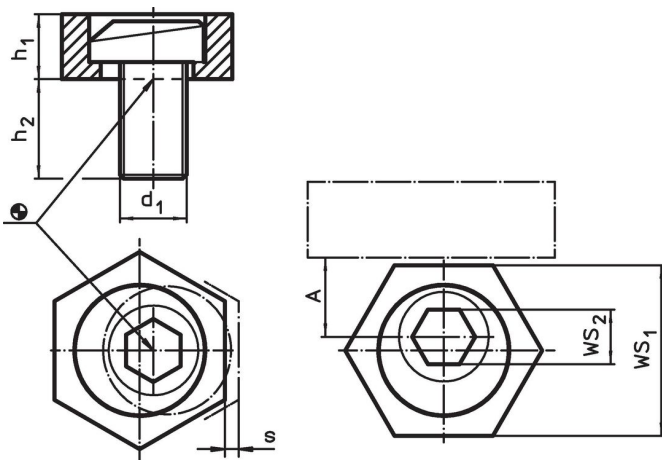

Order information

d ₁	Dimensions			s	A	WS		Clamping force max. [kN]	Tightening torque max. [Nm]	[g]	Art. No.
	h ₁	h ₂	[mm]			WS ₁	WS ₂				
Brass											
M16	12.7	28.5		2.5	15	30.13	12	12	120	108	23270.0116

Application example

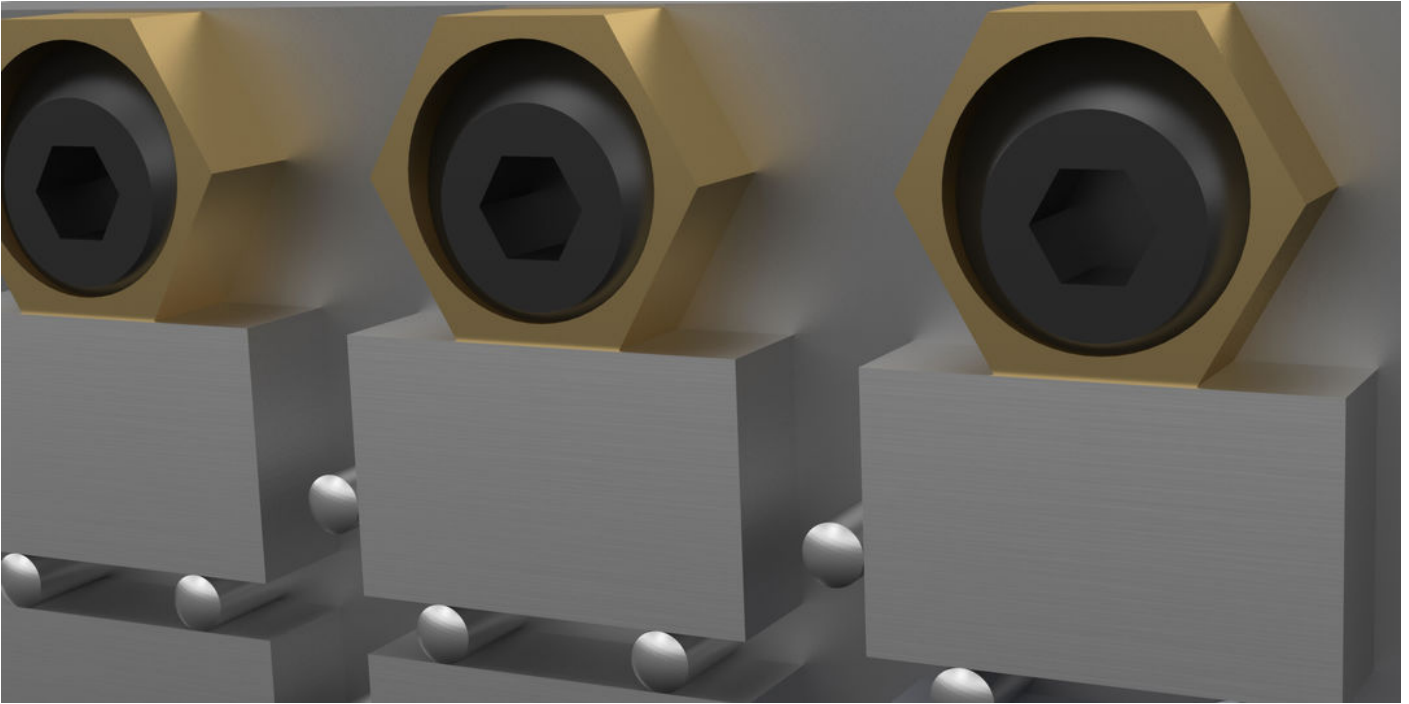

Compliance

RoHS compliant

Compliant according to Directive 2011/65/EU and Directive 2015/863.

Does not contain SVHC substances

No SVHC substances with more than 0.1% w/w contained - SVHC list [REACH] as of 23.01.2024.

Does not contain Proposition 65 substances

No Proposition 65 substances included.

<https://www.P65Warnings.ca.gov/>

Free from Conflict Minerals

This product does not contain any substances designated as "conflict minerals" such as tantalum, tin, gold or tungsten from the Democratic Republic of Congo or adjacent countries.