

Locating Clamps

23230.0450



Product Description

Suitable for a simultaneous "positioning" and "clamping" of workpieces. The locating element is a precision element which can be assembled from either side. The clamping and locating part adapted to the workpiece is screwed to the cylindrical support. Clamping and locating parts are manufactured by the user according to the individual requirements.

Material

Handle

- Thermosetting plastic PF 31, black, DIN 319

Clamp

- Steel, case-hardened, blackened, ground

Drawing

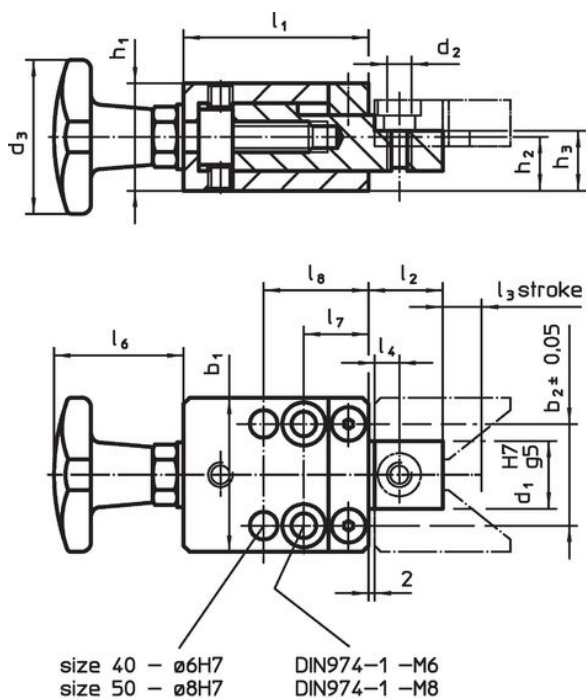

picture 1

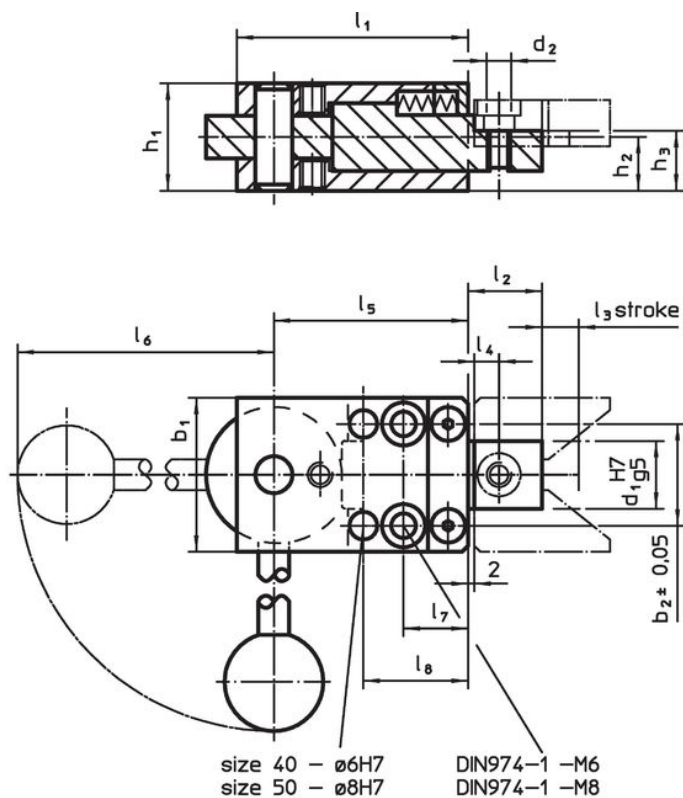

picture 2

Order information

Dimensions															[g]	Art. No.
b ₁	b ₂ ±0.05	d ₁ H7 g5	d ₂	h ₁	h ₂	h ₃	l ₁	l ₂	l ₃	l ₄	l ₅	l ₆	l ₇	l ₈		
[mm]																
with spiral eccentric clamping lever – picture 2																
50	33	22	M8	34.8	17.4	19.4	75	24	4	10	63	145	21	34	1071	23230.0450

Application example



Compliance

RoHS compliant

Contains lead - compliant according to exceptions 6a / 6b / 6c.

Contains SVHC substances >0,1% w/w

Contains lead - SVHC list [REACH] as of 23.01.2024.

Contains Proposition 65 substances



Lead can cause cancer and reproductive harm from exposure
<https://www.P65Warnings.ca.gov/>

Free from Conflict Minerals

This product does not contain any substances designated as "conflict minerals" such as tantalum, tin, gold or tungsten from the Democratic Republic of Congo or adjacent countries.