

Clamps · with soft face, similar to DIN 6314

23190.0046



Product Description

This clamp (clamping claw) according to DIN 6314 with soft face is mainly used in mechanical clamping technology for clamping workpieces. The soft face protects the workpiece from damage. With the combination of nut DIN 6330 B (EH 23070./conical seat DIN 6319 G (EH 23050.) on the clamping bolt and thrust pad DIN 6311 (EH 22560. removable) on the adjusting screw compensates for the lack of parallelity. The clamp can be used either way (soft or hard clamping surface).

Material

Soft face

- Brass, brazed

Clamp

- Heat-treated steel, blackened

Drawing

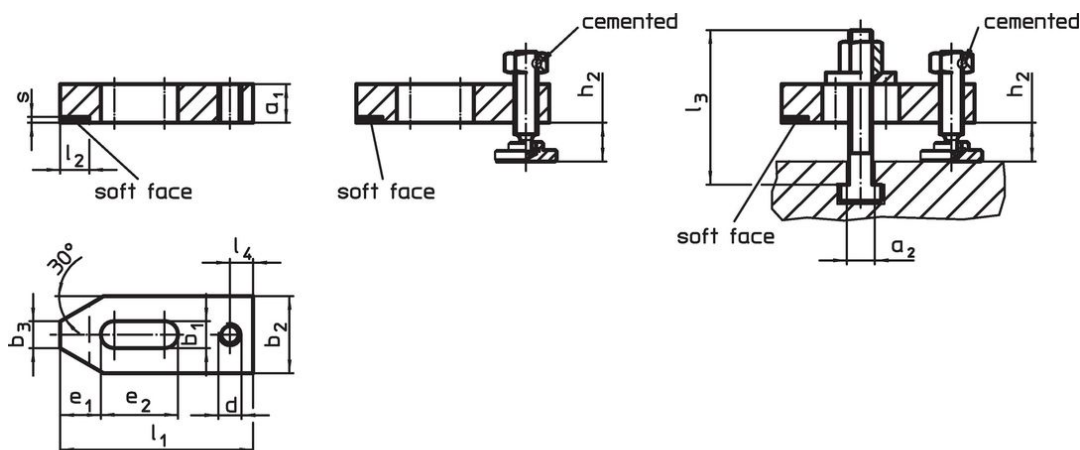

picture 1

picture 2

picture 3

Order information

Nominal dimension b ₁ [mm]	Dimensions													T-slot size [mm]	Clamping height [mm]		Weight [g]	Art. No.
	a ₁	l ₃	a ₂	b ₂	b ₃	d	e ₁	e ₂	l ₁	l ₂ ±1	l ₄	s -0.5	h ₂ min.		h ₂ max.			
18	25	160	15.6	50	18	M16	26	45	125	20	16	3	16	12	87	1630	23190.0046	

with adjusting screw and clamping bolt – picture 3

Application example



Compliance

RoHS compliant

Contains lead - compliant according to exceptions 6a / 6b / 6c.

Contains SVHC substances >0,1% w/w

Contains lead - SVHC list [REACH] as of 23.01.2024.

Contains Proposition 65 substances



Lead can cause cancer and reproductive harm from exposure
<https://www.P65Warnings.ca.gov/>

Free from Conflict Minerals

This product does not contain any substances designated as "conflict minerals" such as tantalum, tin, gold or tungsten from the Democratic Republic of Congo or adjacent countries.