

Clamps · slotted, with adjustable counter piece, with stud

23185.0218

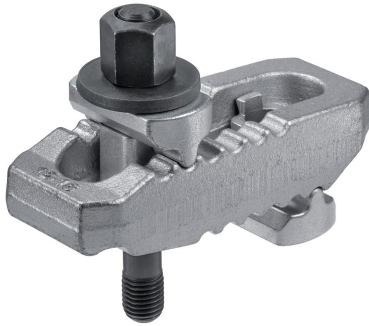

Product Description

The thrust pad and the counter element are connected with the clamp and therefore secured against loss. Consequently, the clamp is quickly ready for use. The clamp is equipped with two flat noses and can be turned around depending on the case of application.

Material

Screw

- Heat-treated steel

Nut

- Heat-treated steel

Disc

- Heat-treated steel

Clamp

- Steel, tempered, zinc-plated by galvanization

More information

References

Larger clamping heights can be reached by the use of a support extension (EH 23185.).

Further products

- Support Extensions, for straight clamps, slotted, with adjustable counter piece

Drawing

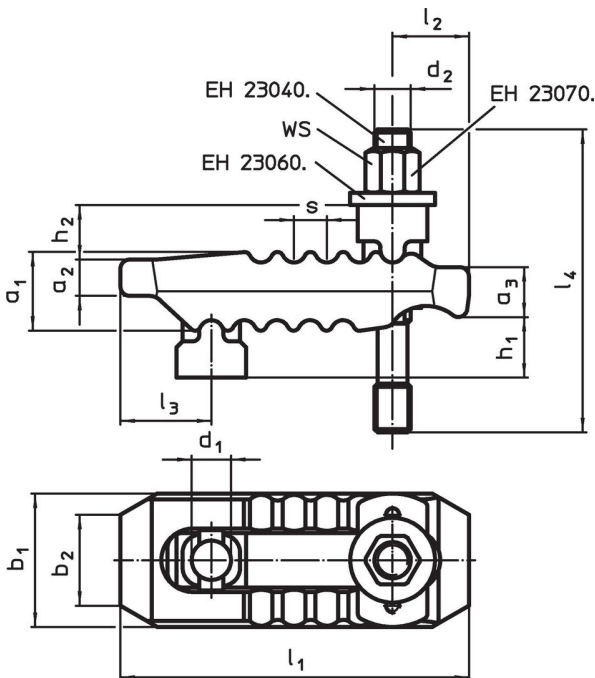

Order information

Nominal dimension d_1 [mm]	Dimensions													WS [mm]	Clamping force ¹⁾ max. [kN]	📦 [g]	Art. No.
	d_2	l_4	h_1	h_2	a_1	a_2	a_3	b_1	b_2	l_1	l_2	l_3	s				
21	M16	160	0 – 40	30	42	20	27	62	30	187	44	44	14	24	60	2512	23185.0218

¹⁾ stated clamping forces in optimal clamping position (smallest distance of the socket head screw to the clamping position). Clamping forces can vary depending on clamping, strength class of the socket head screw and condition of the thread (lubrication).

Compliance

RoHS compliant

Compliant according to Directive 2011/65/EU and Directive 2015/863.

Does not contain SVHC substances

No SVHC substances with more than 0.1% w/w contained - SVHC list [REACH] as of 27.06.2024.

Does not contain Proposition 65 substances

No Proposition 65 substances included.

<https://www.P65Warnings.ca.gov/>

Free from Conflict Minerals

This product does not contain any substances designated as "conflict minerals" such as tantalum, tin, gold or tungsten from the Democratic Republic of Congo or adjacent countries.