

Clamps · with nose
23180.0117



Product Description

This clamp (clamping claw) with nose is mainly used in mechanical clamping technology for clamping workpieces.

Material

- Heat-treated steel, tempered, blackened

Drawing

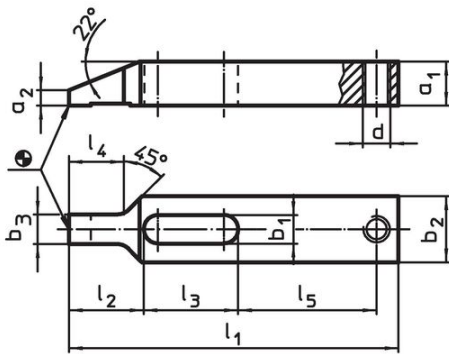

picture 1

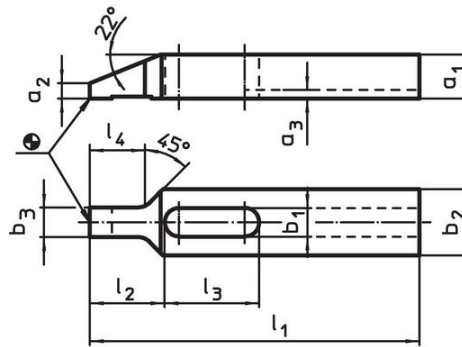

picture 2

Order information

Nominal dimension b_1 [mm]	Dimensions										Art. No.	
	l_1	a_1	a_2	b_2	b_3	d	l_2	l_3	l_4	l_5		[g]
with thread for adjusting screw – picture 1												
17	175	25	9	35	15.5	M16	40	52	29	70	828	23180.0117

Application example

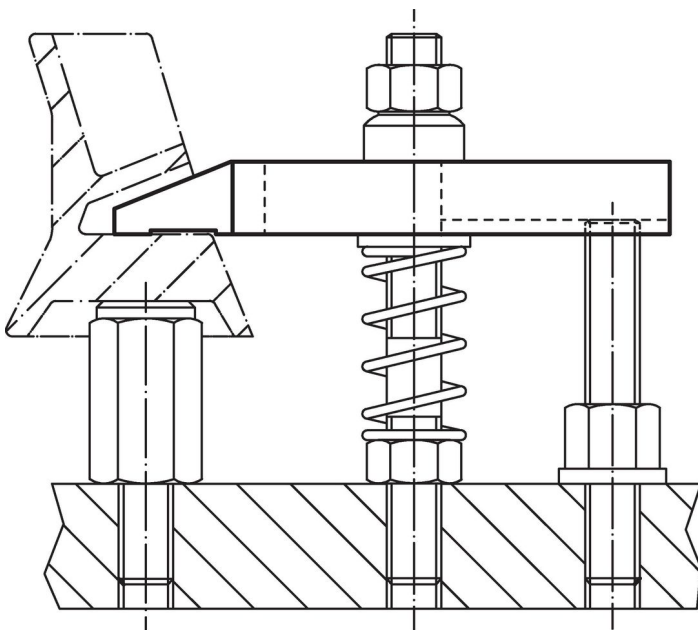

Compliance

RoHS compliant

Compliant according to Directive 2011/65/EU and Directive 2015/863.

Does not contain SVHC substances

No SVHC substances with more than 0.1% w/w contained - SVHC list [REACH] as of 23.01.2024.

Does not contain Proposition 65 substances

No Proposition 65 substances included.

<https://www.P65Warnings.ca.gov/>

Free from Conflict Minerals

This product does not contain any substances designated as "conflict minerals" such as tantalum, tin, gold or tungsten from the Democratic Republic of Congo or adjacent countries.