

## Bushings · for positioning clamping pins

23111.0734



### Product Description

These bushings for positioning clamping pins are available as centric and floating versions. Please observe the mounting instruction.

### Material

- Case-hardened steel, case-hardened, blackened

### Assembly

Two centering bushings and two floating bushings are to be mounted into the plate to be clamped in order to guarantee an optimal repeatability.

### Characteristic

The floating bushing has a groove that serves as a differentiation mark.

### Drawing

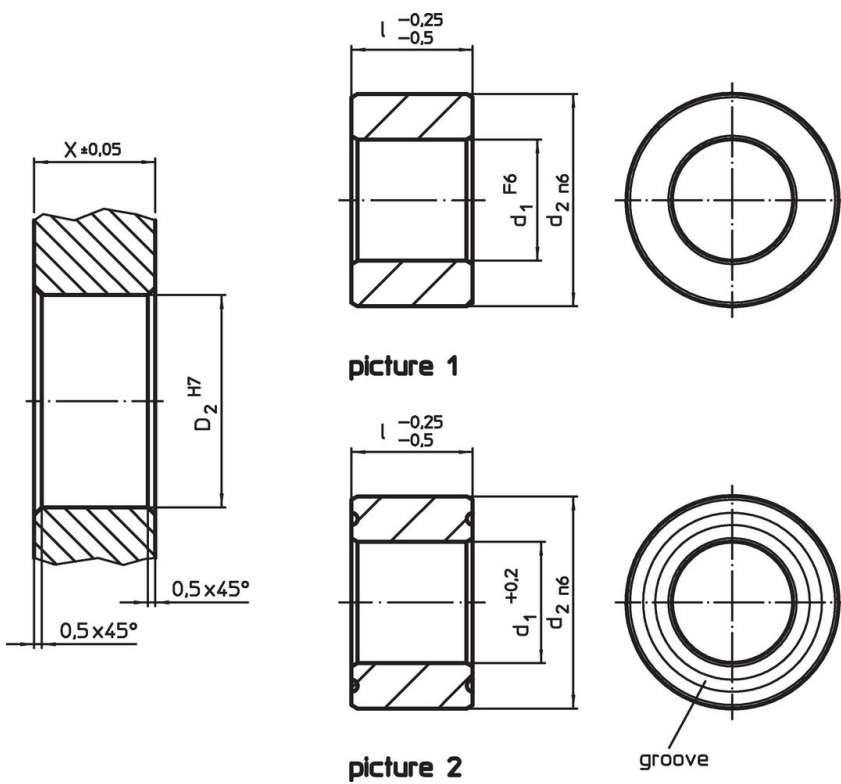

### Order information

d <sub>1</sub> +0.2	Dimensions		d <sub>2</sub> n6	Location hole		[g]	Art. No.
	l	[mm]		X	D <sub>2</sub> H7		
	-0.25 -0.5			±0.05			
floating – picture 2, Case-hardened steel							
16.8	25		25	25	25	51	23111.0734

## Compliance

### RoHS compliant

Compliant according to Directive 2011/65/EU and Directive 2015/863.

### Does not contain SVHC substances

No SVHC substances with more than 0.1% w/w contained - SVHC list [REACH] as of 27.06.2024.

### Does not contain Proposition 65 substances

No Proposition 65 substances included.

<https://www.P65Warnings.ca.gov/>

### Free from Conflict Minerals

This product does not contain any substances designated as "conflict minerals" such as tantalum, tin, gold or tungsten from the Democratic Republic of Congo or adjacent countries.