

Positioning Clamping Pins

23111.0118



Product Description

The positioning clamping pin allows fast clamping, fastening, adjusting, changing and securing of workpieces, plates, fixture systems etc.

Material

- Stainless steel 1.4542, precipitation-hardened

Operation

By tightening the clamping bolt, the positioning clamping pin is centred and clamped in the locating bushing by means of four balls. The clamping bolt can be operated manually via a removable handle (Art. No. 23111.0900/.0902) or using a hexagon key.

More information

Accessories

Suitable bushings are available.

Further products

- Manual Handles, for positioning clamping pins
- Bushings, for positioning clamping pins
- Locating Bushings, for positioning clamping pins, for press fit
- Locating Bushings, for positioning clamping pins, for screw fit

Drawing

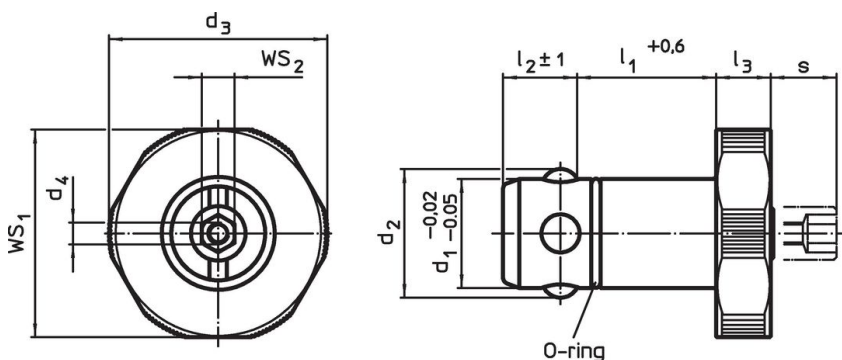

Order information

d ₁		l ₁		d ₂		Dimensions			For base plates ±0.05	WS ₁	WS ₂	Holding force		Art. No.
-0.02	-0.05	+0.6		d ₃	d ₄	l ₂	l ₃	s						
				[mm]					max.	[mm]	[mm]	[kN]	[g]	
Stainless steel														
16	30	18.7	32	M4	13.6	10	9	25	30	6	5	125	23111.0118	

Application example



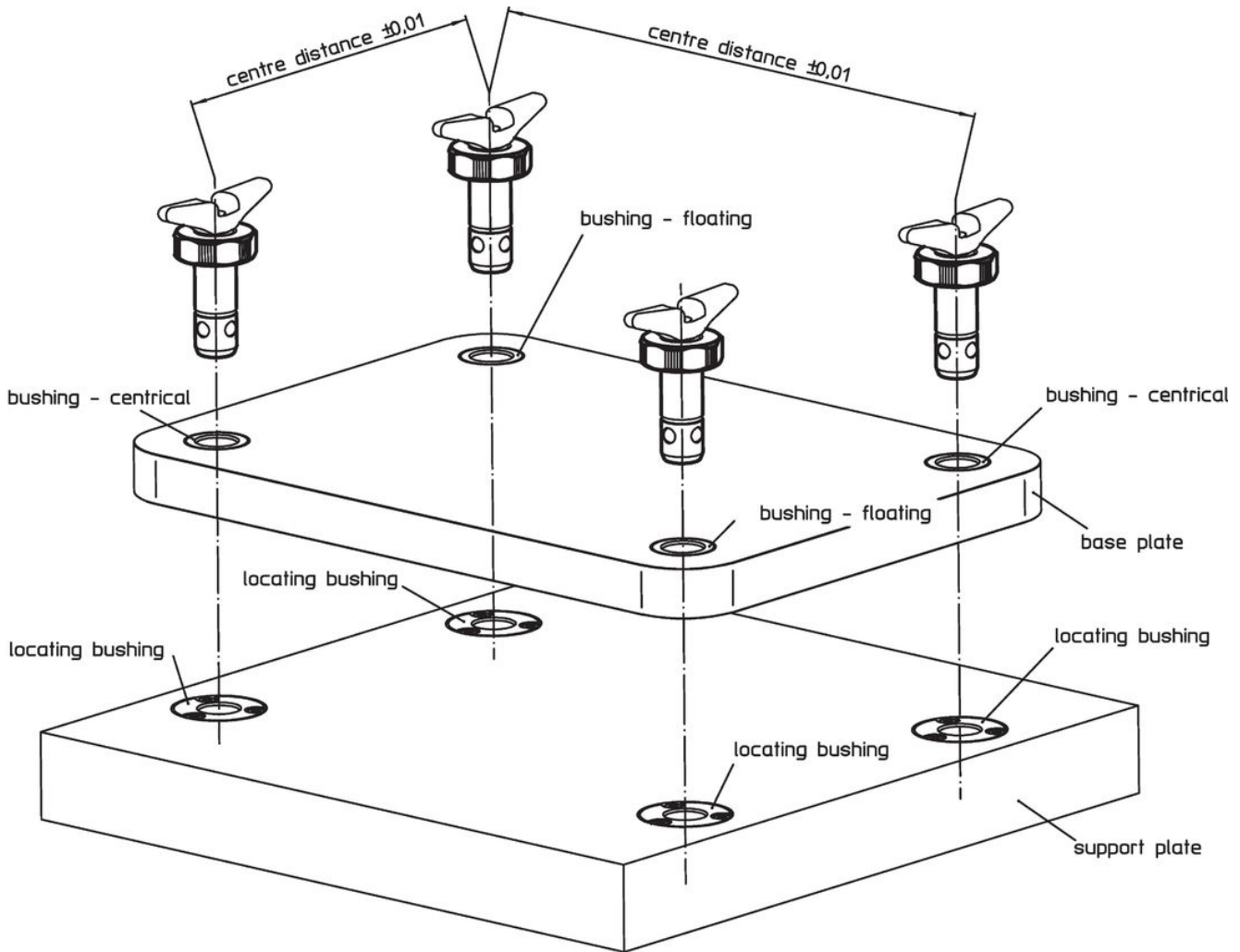

Compliance

RoHS compliant

Compliant according to Directive 2011/65/EU and Directive 2015/863.

Does not contain SVHC substances

No SVHC substances with more than 0.1% w/w contained - SVHC list [REACH] as of 27.06.2024.

Does not contain Proposition 65 substances

No Proposition 65 substances included.

<https://www.P65Warnings.ca.gov/>

Free from Conflict Minerals

This product does not contain any substances designated as "conflict minerals" such as tantalum, tin, gold or tungsten from the Democratic Republic of Congo or adjacent countries.