

Positioning Clamping Pins

23111.0018



Product Description

The positioning clamping pin allows fast clamping, fastening, adjusting, changing and securing of workpieces, plates, fixture systems etc.

Material

- Heat-treated steel, tempered, blackened

Operation

By tightening the clamping bolt, the positioning clamping pin is centred and clamped in the locating bushing by means of four balls. The clamping bolt can be operated manually via a removable handle (Art. No. 23111.0900/.0902) or using a hexagon key.

More information

Accessories

Suitable bushings are available.

Further products

- Manual Handles, for positioning clamping pins
- Bushings, for positioning clamping pins
- Locating Bushings, for positioning clamping pins, for press fit
- Locating Bushings, for positioning clamping pins, for screw fit

Drawing

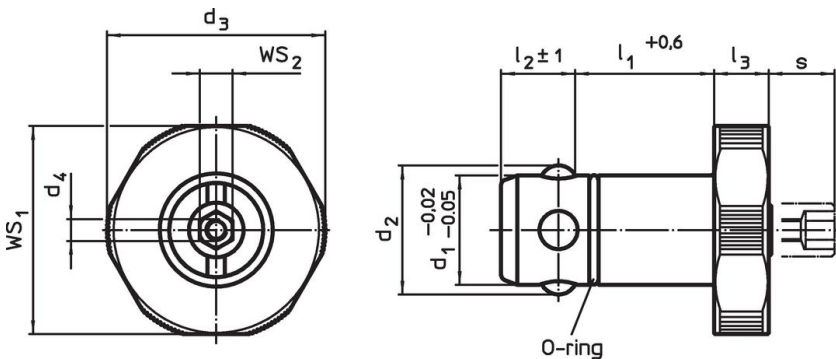

Order information

Dimensions									For base plates ±0.05	WS ₁	WS ₂	Holding force		Art. No.
d ₁	l ₁	d ₂	d ₃	d ₄	l ₂	l ₃	s	[mm]						
-0.02 -0.05	+0.6				±1		max.							
[mm]									[mm]	[mm]	[mm]	[kN]	[g]	
Heat-treated steel														
16	30	18.7	32	M4	13.6	10	9	25	30	6	5	125	23111.0018	

Application example

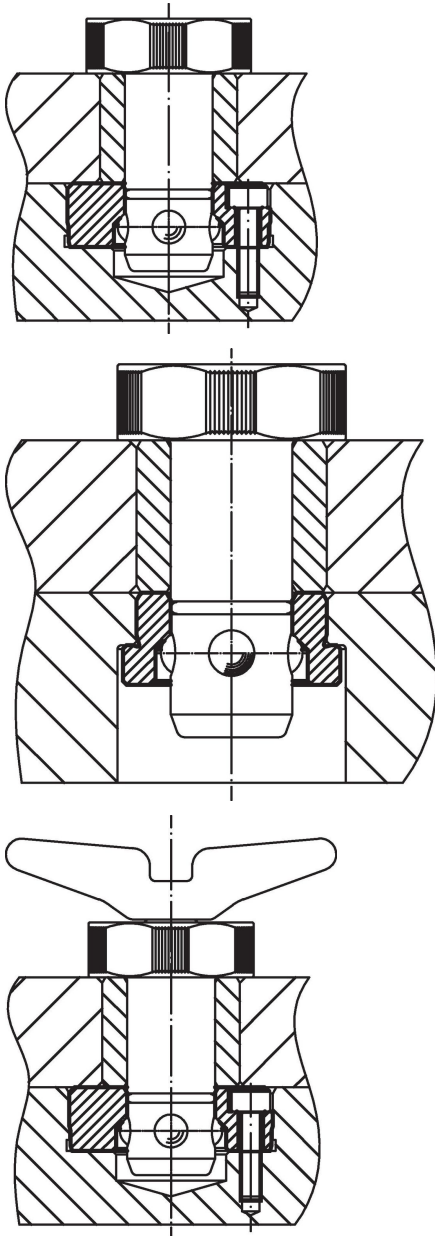

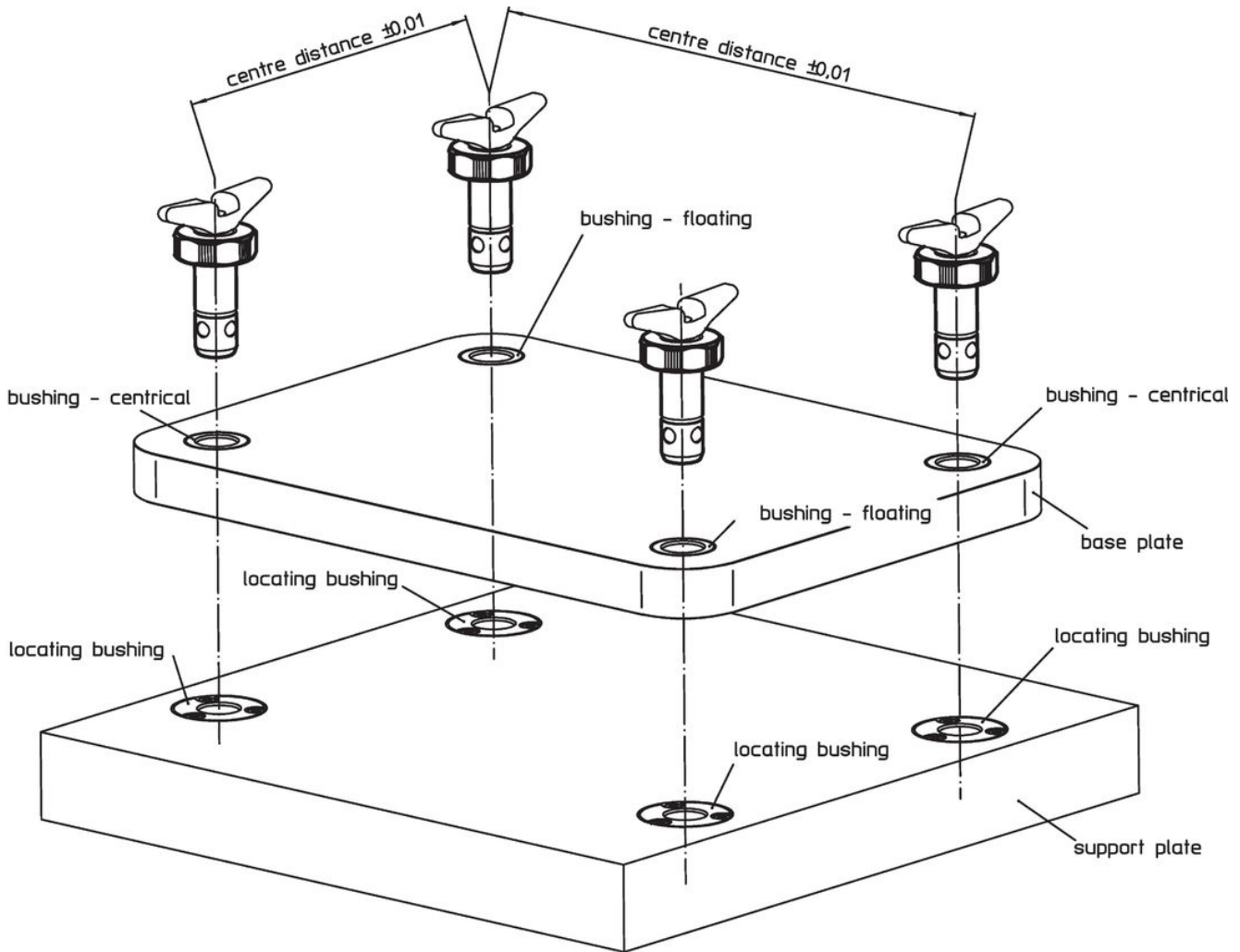

Compliance

RoHS compliant

Contains lead - compliant according to exceptions 6a / 6b / 6c.

Contains SVHC substances >0,1% w/w

Contains lead - SVHC list [REACH] as of 23.01.2024.

Contains Proposition 65 substances



Lead can cause cancer and reproductive harm from exposure
<https://www.P65Warnings.ca.gov/>

Free from Conflict Minerals

This product does not contain any substances designated as "conflict minerals" such as tantalum, tin, gold or tungsten from the Democratic Republic of Congo or adjacent countries.