

Ball-Ended Thrust Screws • headed, round ball

22710.0102



Product Description

Ball-ended thrust screws can also be used for positioning and clamping, tightening or supporting of non-parallel surfaces.

Material

Ball

- Ball-bearing steel, hardened

Screw

- Heat-treated steel, $1200 \pm 100 \text{ N/mm}^2$

More information

Notes

Special types on request.

References

Thread lock on request, please refer to appendix - Technical Data -

Drawing



Order information

d ₁	l ₁	Dimensions			Ball diameter	WS	Load capacity for static load ¹⁾ max.	g	Art. No.
		d ₂	l ₃	l ₄					
round ball, Heat-treated steel									
M10	26.7	16	10	4.5	7	8	20	24	22710.0102

¹⁾ Statements on load capacity are not valid for the stainless steel type.

Application example

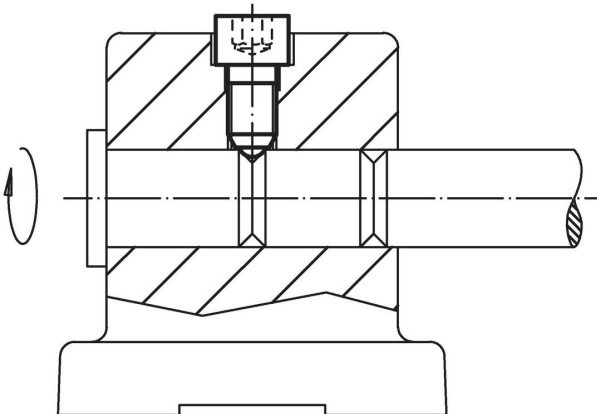

Compliance

RoHS compliant

Compliant according to Directive 2011/65/EU and Directive 2015/863.

Does not contain SVHC substances

No SVHC substances with more than 0.1% w/w contained - SVHC list [REACH] as of 23.01.2024.

Does not contain Proposition 65 substances

No Proposition 65 substances included.

<https://www.P65Warnings.ca.gov/>

Free from Conflict Minerals

This product does not contain any substances designated as "conflict minerals" such as tantalum, tin, gold or tungsten from the Democratic Republic of Congo or adjacent countries.