

Locating Pins · with ball end
22630.0566



Product Description

Ball ended locating pins facilitate easy inserting and removing avoiding clamping inclination.

Material

- Stainless steel 1.4305, ground, surface heat-treated

More information

Further products

- Locating Pins, DIN 6321
- Locating Pins, with bore hole similar to DIN 6321

Drawing

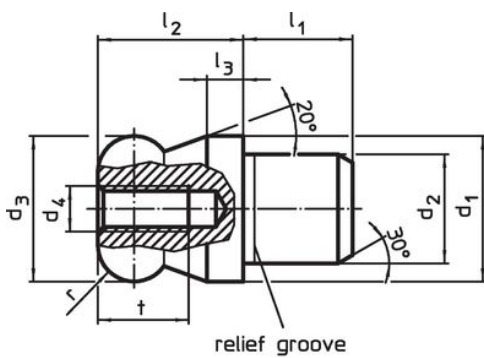

picture 1



picture 2

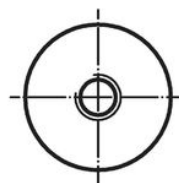
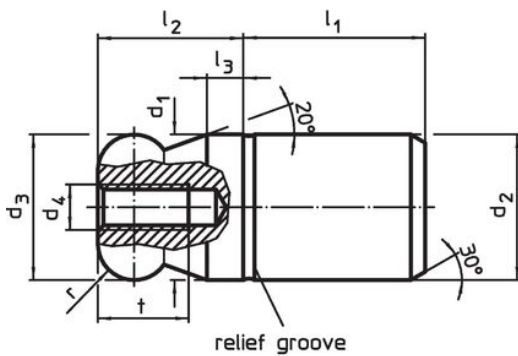

picture 3



picture 4

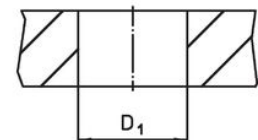

Order information

Dimensions										Location hole		Art. No.
d ₁	d ₂	d ₃	d ₄	l ₁	l ₂	l ₃	t	r		D ₁		
[mm]										[mm]	[g]	
g6	n6	-0.01 -0.05								H7		
ball end round ball, not stepped – picture 3, Stainless steel												
6	6	6	M3	8	6	2	5	1		6	3.4	22630.0566

Application example



Compliance

RoHS compliant

Compliant according to Directive 2011/65/EU and Directive 2015/863.

Does not contain SVHC substances

No SVHC substances with more than 0.1% w/w contained - SVHC list [REACH] as of 23.01.2024.

Does not contain Proposition 65 substances

No Proposition 65 substances included.

<https://www.P65Warnings.ca.gov/>

Free from Conflict Minerals

This product does not contain any substances designated as "conflict minerals" such as tantalum, tin, gold or tungsten from the Democratic Republic of Congo or adjacent countries.