

Hard Metal Inserts

22620.0617



Product Description

Basic element to be mounted into clamping devices, clamping jaws, clamping arms, claw feed systems and so forth.

For an abrasion-proof transmission of high holding forces, e. g. on cast or forged pieces.

Material

Insert

- Hard metal, ribbed

Assembly

Mounting can take place by either soldering, glueing or pressing in. The three positioning tabs guarantee exact centering and when being glued or pressed in, article is secured against rotating. Depending on the individual element choose a mounting diameter between d_1 and d_2 .

Drawing

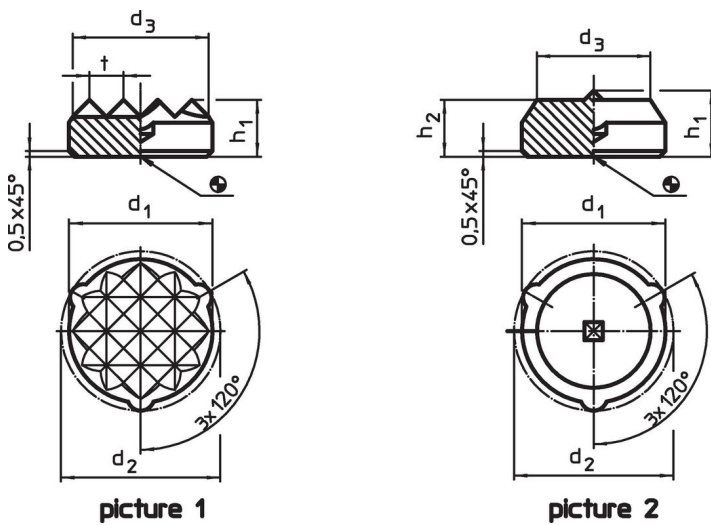

Order information

d_1 ± 0.15	Dimensions				 [g]	Art. No.
	d_2 ± 0.2	d_3 ~	h_1	t		
ribbed – picture 1						
21.6	22.4	21	5	3	21	22620.0617

Application example



Compliance

RoHS compliant

Compliant according to Directive 2011/65/EU and Directive 2015/863.

Does not contain SVHC substances

No SVHC substances with more than 0.1% w/w contained - SVHC list [REACH] as of 27.06.2024.

Does not contain Proposition 65 substances

No Proposition 65 substances included.

<https://www.P65Warnings.ca.gov/>

Free from Conflict Minerals

This product does not contain any substances designated as "conflict minerals" such as tantalum, tin, gold or tungsten from the Democratic Republic of Congo or adjacent countries.