

Hard Metal Inserts • front mounting

22620.0415



Product Description

Basic element to be mounted into clamping devices, clamping jaws, clamping arms, claw feed systems and so forth.

The model with front installation is a particularly good option for applications that cannot be mounted from the rear.

Material

Insert

- Hard metal, ribbed

Body

- Heat-treated steel, tempered, phosphated

Assembly

Installation is performed using a locating hole, and the insert can be fastened from the front using a cap screw.

Drawing

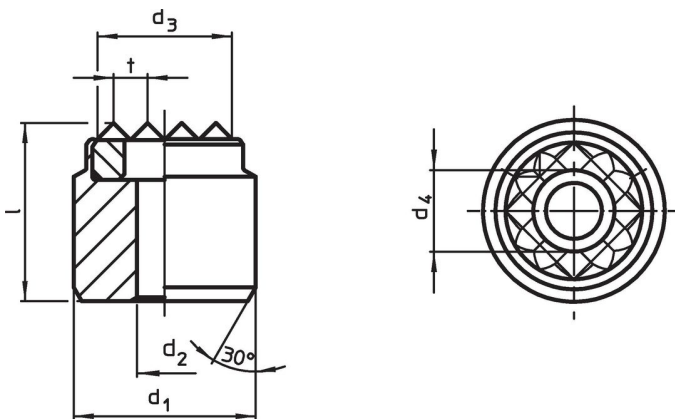

Order information

d ₁ n6	d ₂	Dimensions				l	t	For screws [mm]	[g]	Art. No.
		d ₃	d ₄	[mm]						
20	4.5	16	7.5			13	3	M4	29	22620.0415

Application example

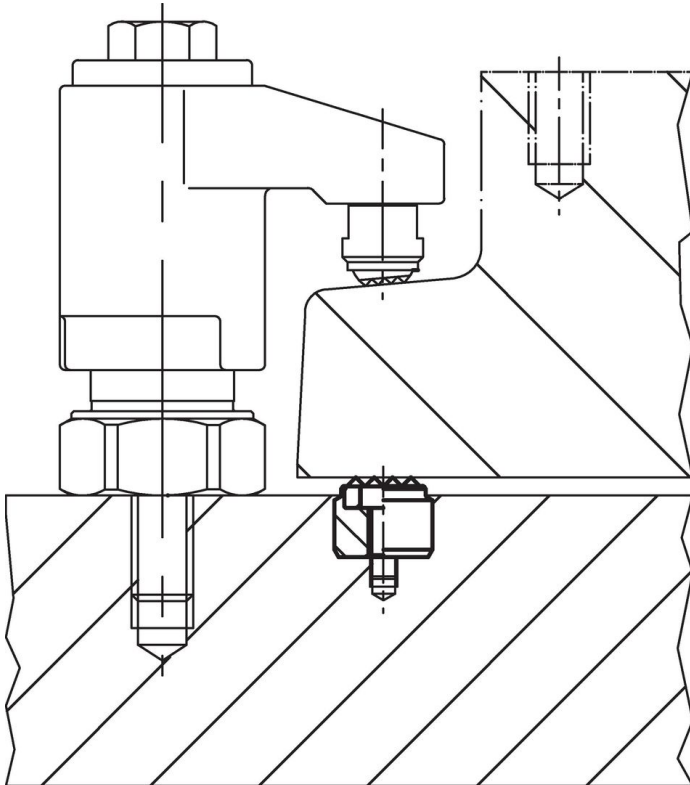

Compliance

RoHS compliant

Contains lead - compliant according to exceptions 6a / 6b / 6c.

Contains SVHC substances >0,1% w/w

Contains lead - SVHC list [REACH] as of 27.06.2024.

Contains Proposition 65 substances



Lead can cause cancer and reproductive harm from exposure
<https://www.P65Warnings.ca.gov/>

Free from Conflict Minerals

This product does not contain any substances designated as "conflict minerals" such as tantalum, tin, gold or tungsten from the Democratic Republic of Congo or adjacent countries.