

Mounting Pads · protected against slipping

22590.1016



Product Description

Mounting pads can be used as foot or thrust pad. Not parallel bearing surfaces up to 15° degrees can be compensated.
The plastic cover on the mounting pad prevents slipping.

Material

Ball element

- Free cutting steel, induction-hardened, blackened.

Rubber cap

- Rubber, black

Pad

- Heat-treated steel, tempered, blackened

More information

Notes

For the versions $d_1 = M10$ and $M12$ the lock nut conforms to DIN 934.

Drawing

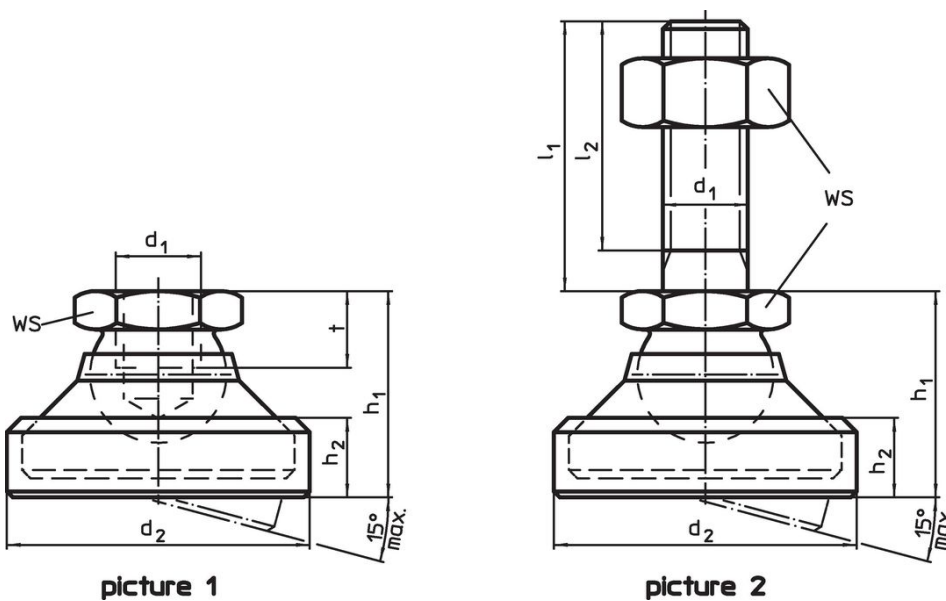

picture 1

picture 2

Order information

d_1	d_2	Dimensions			WS	Load capacity for static load max.	[g]	Art. No.
		h_1	h_2	t				
pad and ball element – picture 1, Heat-treated steel								
M16	56	37.5	15.5	13.5	24	45	241	22590.1016

Compliance

RoHS compliant

Compliant according to Directive 2011/65/EU and Directive 2015/863.

Does not contain SVHC substances

No SVHC substances with more than 0.1% w/w contained - SVHC list [REACH] as of 23.01.2024.

Does not contain Proposition 65 substances

No Proposition 65 substances included.

<https://www.P65Warnings.ca.gov/>

Free from Conflict Minerals

This product does not contain any substances designated as "conflict minerals" such as tantalum, tin, gold or tungsten from the Democratic Republic of Congo or adjacent countries.