

## Threaded Lock Pins • self-locking

22355.0503



## Product Description

Threaded lock pins are used for quick fastening, locking, adjusting, changing, clamping, connecting and securing. Quickly and easily unlockable for frequently repeated connections. By pressing the button, the threaded segments unlock and the threaded lock pin can be inserted into or removed from a threaded hole. A time-consuming screwing in and out is unnecessary. The threaded lock pin is characterised by the following features:

- Corrosion-protected
- No time-consuming screwing in and out
- Self-locking due to spring load

## Material

## Pin part

- Steel, manganese-phosphated

## Handle

- Thermoplastic PA 6, black, dull similar to RAL 9005

## Press button

- Aluminium, orange, anodised

## Threaded element

- Stainless steel 1.4542, precipitation-hardened

## Spring

- Stainless Steel

## Assembly

Threaded lock pins can only be mounted into a thread that is true to gauge.

## Mounting:

1. Press in the button and hold it down.
2. Insert the threaded lock pin.
3. Release the button (The button must be back in its original position.).
4. Tighten the threaded lock pin by hand as required.
5. It must be ensured that the threaded segments are engaged in the mounting thread.

## Dismantling:

1. Unscrew the threaded lock pin approx. a quarter of a turn anticlockwise.
2. Press in the button and hold it down.
3. Remove the threaded lock pin.
4. Release the button.

## Operation

The threaded segments are unlocked by pressing the button.

## More information

## Notes

Special types on request.

Due to the thread geometry, the clamping force is higher with the smaller thread sizes.

## Accessories

Can easily be fitted with retaining cable EH 22355.

## Further products

- Threaded Lock Pins, self-locking, with axial bearing
- Retaining Cables, for threaded lock pin

## Drawing

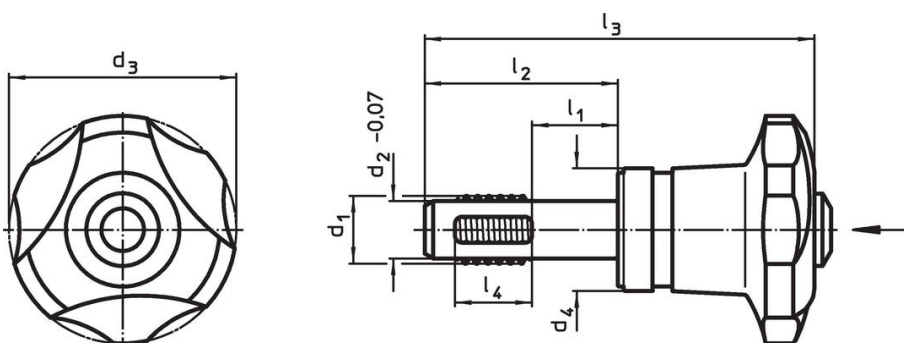

Order information

Dimensions									Locating thread	Temperature		Tightening torque max.	Clamping force max.	Established tightening torque ~ <sup>1)</sup>	Clamping force ~ <sup>2)</sup>	Weight	Shearing resistance, two-shear <sup>3)</sup> min.	Art. No.
d <sub>1</sub>	l <sub>1</sub>	d <sub>2</sub> -0.07	d <sub>3</sub> -1	d <sub>4</sub>	l <sub>2</sub>	l <sub>3</sub>	l <sub>4</sub>	[mm]		min.	max.							
Steel, manganese-phosphated																		
M16	15	13.8	40	21.6	34	68.6	12	M16	-30	80	5	2.1	3.5	1.5	116	62.9	22355.0503	

<sup>1)</sup> Average hand force established in trials.

<sup>2)</sup> Average value established in trials.

<sup>3)</sup> Shearing resistance similar to DIN 50141; values apply to applications in plugged condition (without applied tightening torque).

Application example

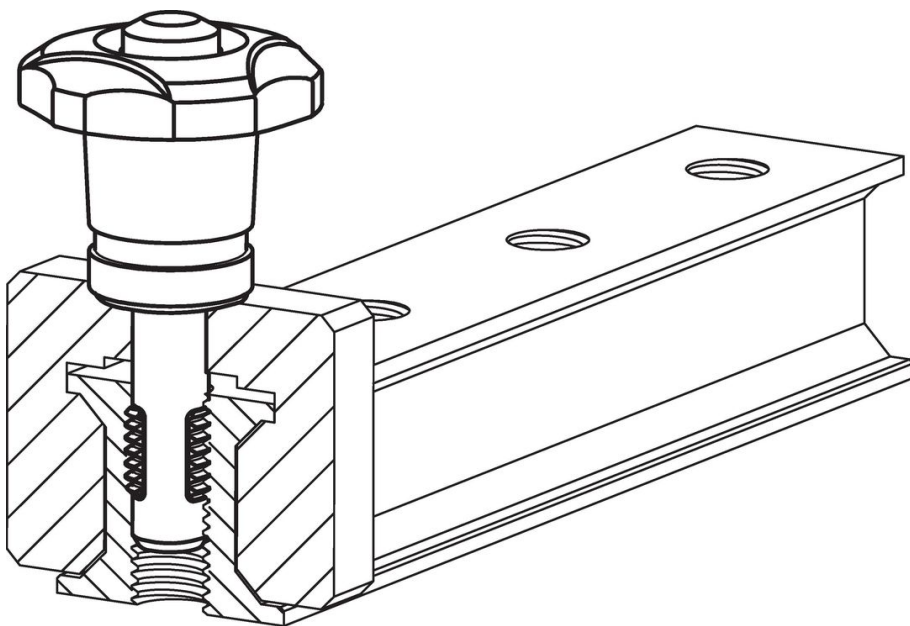

Compliance

RoHS compliant

Contains lead - compliant according to exceptions 6a / 6b / 6c.

Contains SVHC substances >0,1% w/w

Contains lead - SVHC list [REACH] as of 23.01.2024.

Contains Proposition 65 substances



Lead can cause cancer and reproductive harm from exposure

<https://www.P65Warnings.ca.gov/>

Free from Conflict Minerals

This product does not contain any substances designated as "conflict minerals" such as tantalum, tin, gold or tungsten from the Democratic Republic of Congo or adjacent countries.