

## Ball Lock Pins • self-locking, with button handle

22350.0291



### Product Description

For quick fastening, locking, adjusting, changing and securing. Quickly and easily unlockable for frequently repeated connections.

All versions are corrosion resistant. When using stainless steel 1.4542: high-strength, hardened, abrasion resistant pin with high load capacity.

Compact design with button handle.

### Material

#### Pin part

- Stainless steel 1.4542, precipitation-hardened

#### Handle

- Aluminium, black similar to RAL 9005

#### Press button

- Stainless steel, black

#### Spring

- Stainless steel

### Operation

The balls are unlocked by pressing the button.

### Characteristic

Types from stainless steel 1.4542 with marking below the balls.

### More information

### Notes

Special types on request.

### Accessories

Can easily be fitted with retaining cable EH 22400.

### Further products

- Locating Bushings, for ball lock pins and socket pins
- Locating Bushings, with flange, for ball lock pins and socket pins
- Retaining Cables
- Positioning Bushings, with collar, DIN 172 A
- Positioning Bushings, without collar, DIN 179 A
- Ball Lock Pins with Button Handle, single acting - comply with NAS / MS17984

### Drawing



\*\* Types from stainless steel 1.4542 with marking.

### Order information

Dimensions									Location hole	Temperature		Weight	Shearing resistance, two-shear <sup>1)</sup>	Art. No.
d <sub>1</sub>	l <sub>1</sub>	d <sub>2</sub>	d <sub>3</sub>	d <sub>4</sub>	l <sub>2</sub>	l <sub>3</sub>	l <sub>4</sub>	l <sub>5</sub>	H11	min.	max.	[g]	min.	
[mm]									[mm]	[°C]			[kN]	
Stainless steel														
20	70	24.8	23.4	40	17	43.1	34.5	28.5	20	-30	150	291	403	22350.0291

<sup>1)</sup> Shearing resistance similar to DIN 50141

### Application example

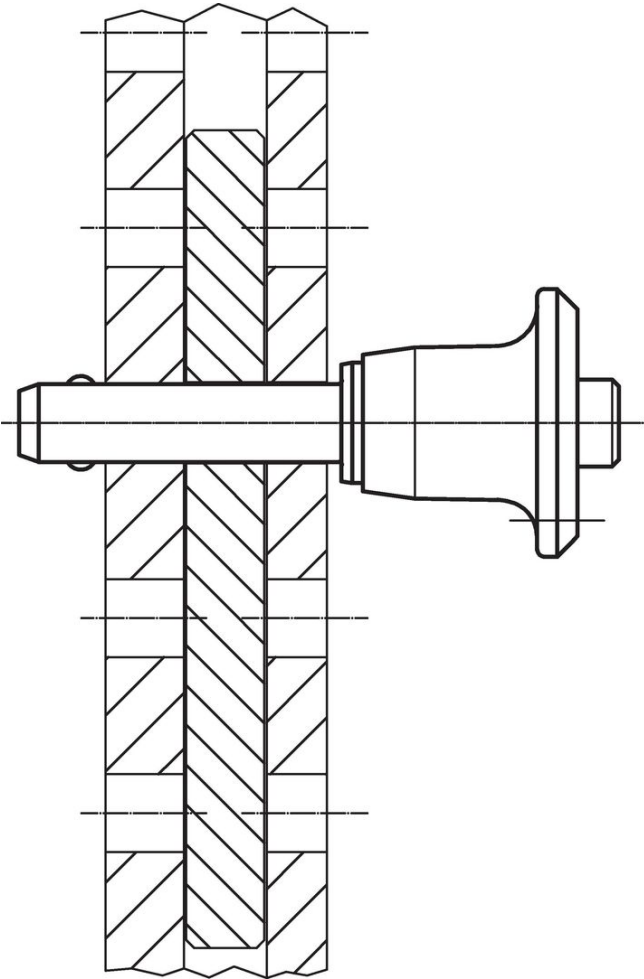

### Compliance

#### Non-RoHS compliant

Not compliant according to Directive 2011/65/EU and Directive 2015/863.

#### Contains SVHC substances >0,1% w/w

Contains lead - SVHC list [REACH] as of 27.06.2024.

#### Contains Proposition 65 substances



Lead can cause cancer and reproductive harm from exposure

<https://www.P65Warnings.ca.gov/>

#### Free from Conflict Minerals

This product does not contain any substances designated as "conflict minerals" such as tantalum, tin, gold or tungsten from the Democratic Republic of Congo or adjacent countries.