

**Index Plungers · with hexagon collar, stainless steel A4**  
22120.1092



**Product Description**

Index plungers are used for indexing bores.  
The stainless steel A4 version ensures maximum corrosion resistance.

**Material**

**Body**

- Stainless steel 1.4401

**Locking pin**

- Stainless steel 1.4401 nickel-plated

**Knob**

- Stainless steel 1.4401

**Lock nut**

- Stainless steel 1.4401

**More information**

**Notes**

Knob not removable.  
Lock nuts have to be purchased separately.

**Drawing**

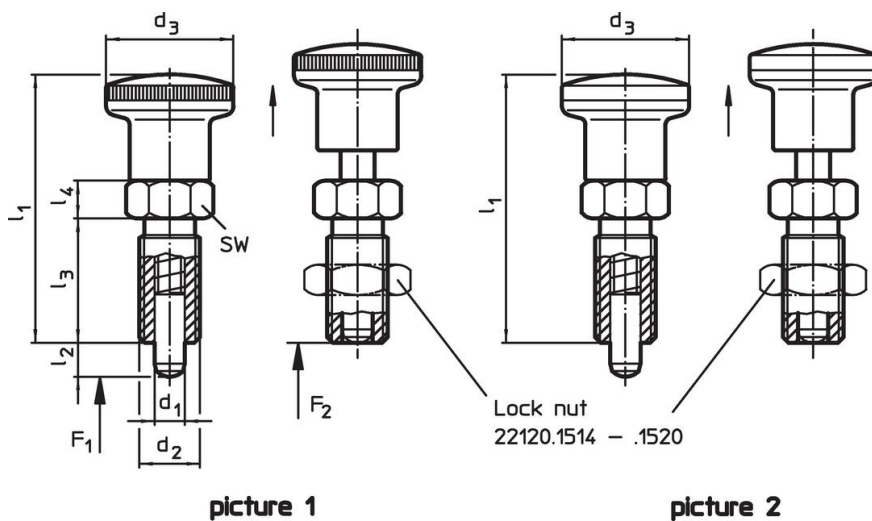

## Order information

Dimensions							Spring load <sup>1)</sup>		🌡️	🏋️	Art. No.
d <sub>1</sub>	d <sub>2</sub>	l <sub>2</sub> min.	d <sub>3</sub>	l <sub>1</sub>	l <sub>3</sub>	l <sub>4</sub>	F <sub>1</sub> ~	F <sub>2</sub> ~	max.		
[mm]							[N]		[°C]	[g]	
<b>with knob from stainless steel – picture 2</b>											
12	M20 x 1,5	15	32	71.5	33	10	9	32	100	203	22120.1092

<sup>1)</sup> statistical average value

## Accessories

	Dimensions d <sub>2</sub> [mm]	Wrench size [mm]	🏋️ [g]	Art. No.
<b>Lock nuts ISO 8675 (DIN 439), Stainless steel 1.4401</b>				
	M20 x 1,5	30	33.0	22120.1520

## Compliance

### RoHS compliant

Compliant according to Directive 2011/65/EU and Directive 2015/863.

### Does not contain SVHC substances

No SVHC substances with more than 0.1% w/w contained - SVHC list [REACH] as of 23.01.2024.

### Does not contain Proposition 65 substances

No Proposition 65 substances included.

<https://www.P65Warnings.ca.gov/>

### Free from Conflict Minerals