

## Index Plungers · with hexagon collar, short 22120.0258



### Product Description

Index plungers are used for indexing bores.  
The small dimensions are a feature of these index plungers.

### Material

#### Body

- Stainless steel 1.4305

#### Locking pin

- Stainless steel 1.4305, nickel-plated

#### Knob

- Thermoplastic PA 6, black, dull

### Assembly

The screw length can be adapted by distance collars for index plungers (EH 22120.).

### Operation

When using locking index plungers, the knob is pulled-out, turned 90° and secured by a notched catch (when locking pin should not overhang).

### More information

### Notes

Knob not removable.  
Lock nuts have to be purchased separately.

### Further products

- Locating Bushings, for index bolts and index plungers
- Distance Collars, for index plungers

### Drawing

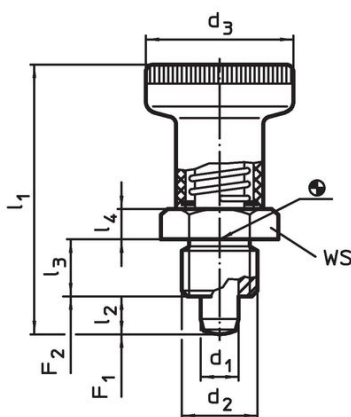

picture 1

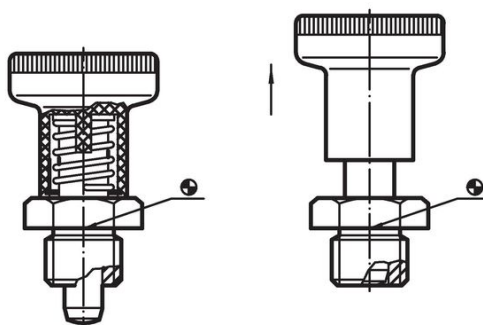



picture 2 with locking

### Order information

Dimensions							WS	Spring load <sup>1)</sup>		Temperature		Weight	Art. No.
d <sub>1</sub>	d <sub>2</sub>	d <sub>3</sub>	l <sub>1</sub>	l <sub>2</sub>	l <sub>3</sub>	l <sub>4</sub>		F <sub>1</sub>	F <sub>2</sub>	min.	max.		
-0.02 -0.05			~	min.	-0.15			~	~				
[mm]													
[N]													
[°C]													
[mm]													
with locking – picture 2, Stainless steel													
8	M16 x 1,5	31	54	8	12	6	19	14	24	-30	80	60	22120.0258

<sup>1)</sup> statistical average value

## Accessories

	Dimensions $d_2$ [mm]	Wrench size [mm]	 [g]	Art. No.
<b>Lock nuts ISO 8675 (DIN 439), Stainless steel</b>				
	M16 x 1,5	24	15.0	22120.0518

## Application example

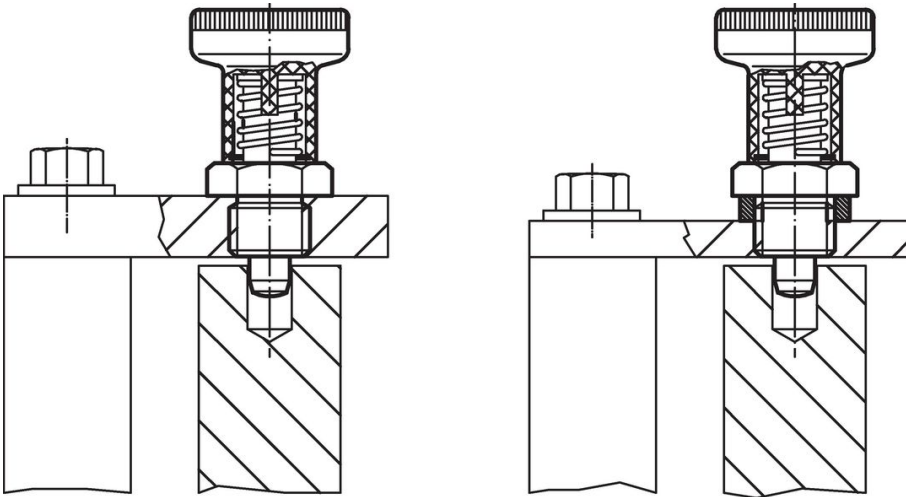

## Compliance

### RoHS compliant

Compliant according to Directive 2011/65/EU and Directive 2015/863.

### Does not contain SVHC substances

No SVHC substances with more than 0.1% w/w contained - SVHC list [REACH] as of 23.01.2024.

### Does not contain Proposition 65 substances

No Proposition 65 substances included.

<https://www.P65Warnings.ca.gov/>

### Free from Conflict Minerals

This product does not contain any substances designated as "conflict minerals" such as tantalum, tin, gold or tungsten from the Democratic Republic of Congo or adjacent countries.