

Index Plungers Compact • with hexagon collar and locking

22110.0126



Product Description

Index plungers are used for indexing bores.
Types with / without lock have the same building height.
Due to a thread recess the index plungers can be completely screwed in.

Material

Body

- Steel, blackened

Locking pin

- Steel, hardened

Knob

- Thermoplastic PA 6, black, dull

Assembly

The screw length can be adapted by distance collars for index plungers (EH 22120.).

Operation

The knob is pulled-out, turned 90° and secured by a notched catch (when locking pin should not overhang).

More information

Notes

Knob not removable.
Lock nuts have to be purchased separately.

Further products

- Mounting Blocks, for index bolts and index plungers, die-cast
- Locating Bushings, for index bolts and index plungers
- Distance Collars, for index plungers

Drawing

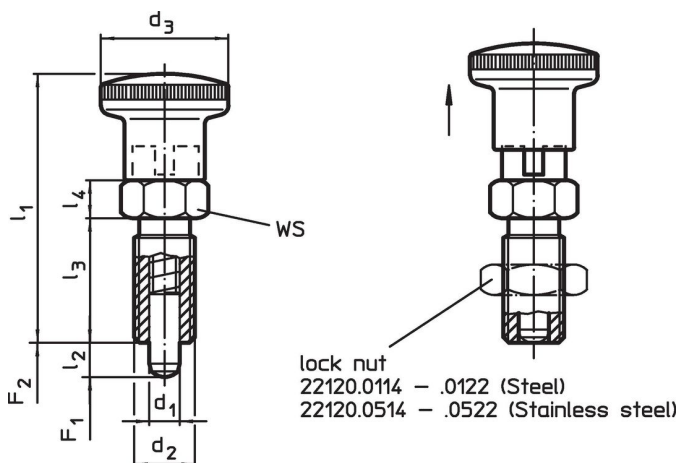

Order information

Dimensions							WS [mm]	Spring load ¹⁾		Temperature		Weight [g]	Art. No.
d ₁ -0.02 -0.05	d ₂	l ₂ min.	d ₃	l ₁	l ₃	l ₄		F ₁ ~	F ₂ ~	min.	max.		
[mm]							[mm]	[N]		[°C]		[g]	
with knob, black, Steel													
5	M10 x 1	5	19	40	18	6	12	5	15	-30	80	20	22110.0126

¹⁾ statistical average value

Accessories

Image	Dimensions	Wrench size	Weight [g]	Art. No.
	d ₂ [mm]	[mm]		
Lock nuts ISO 8675 (DIN 439), Steel				
	M10 x 1	16	5.2	22120.0115

Application example



Compliance

RoHS compliant

Contains lead - compliant according to exceptions 6a / 6b / 6c.

Contains SVHC substances >0,1% w/w

Contains lead - SVHC list [REACH] as of 23.01.2024.

Contains Proposition 65 substances



Lead can cause cancer and reproductive harm from exposure
<https://www.P65Warnings.ca.gov/>

Free from Conflict Minerals

This product does not contain any substances designated as "conflict minerals" such as tantalum, tin, gold or tungsten from the Democratic Republic of Congo or adjacent countries.