

Spring Plungers • double-sided

22090.0070



Product Description

To be used for locating and securing, as well as electric connection.

Material

Body

- Brass

Ball

- Stainless steel, hardened

Spring

- Stainless steel

More information

Notes

Special types on request.
Spring plungers are specially tested for spring range and forces.

References

Calculation of indexing resistance, please refer to appendix - Technical Data -

Further products

- Locators, with bore hole, for spring plungers
- Locators, smooth, for spring plungers

Drawing

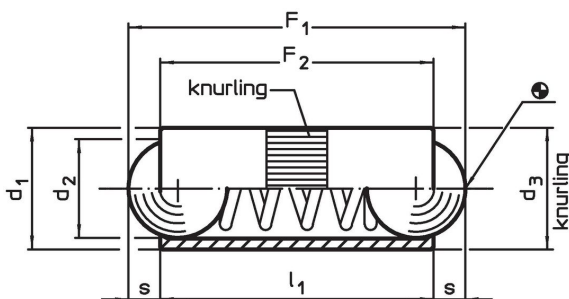

Order information

Dimensions				Stroke s	Spring load ¹⁾		max. [°C]	Location hole H8 [mm]	[g]	Art. No.
d ₁	d ₂	d ₃	l ₁		F ₁ ~	F ₂ ~				
[mm]				[mm]	[N]					
7	6	7.03	14	2	4	12	250	7	3	22090.0070

¹⁾ statistical average value

Application example

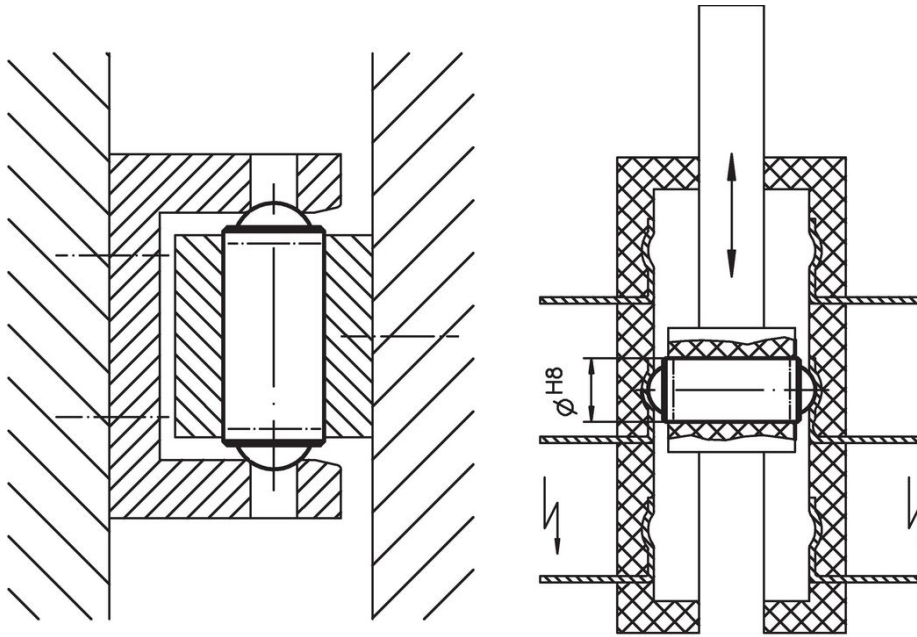

Compliance

RoHS compliant

Contains lead - compliant according to exceptions 6a / 6b / 6c.

Contains SVHC substances >0,1% w/w

Contains lead - SVHC list [REACH] as of 27.06.2024.

Contains Proposition 65 substances



Lead can cause cancer and reproductive harm from exposure
<https://www.P65Warnings.ca.gov/>

Free from Conflict Minerals

This product does not contain any substances designated as "conflict minerals" such as tantalum, tin, gold or tungsten from the Democratic Republic of Congo or adjacent countries.