

Spring Plungers · smooth, with collar and ball

22080.1008



Product Description

Spring plungers can be used for locating or for applying pressure, as a detent or for ejection.

Material

Body

- Stainless steel 1.4303

Ball

- Stainless steel, hardened

Spring

- Stainless steel

Assembly

A tolerance of H7 is recommended for the locating hole of d_1 .

Characteristic

Light spring load: marked with one line



Light spring load

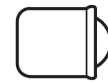

Standard spring load



Heavy spring load

More information

Notes

Special types on request.

Spring plungers are specially tested for spring range and forces.

References

Calculation of indexing resistance, please refer to appendix - Technical Data -

Version with higher spring forces see "EH 22080. Spring Plungers, smooth, long, with collar and ball".

Further products

- Spring Plungers, with collar and ball, front slot
- Spring Plungers, smooth, long, with collar and ball
- Spring Plungers, smooth, with collar and ball, self-clamping
- Locators, with bore hole, for spring plungers
- Locators, smooth, for spring plungers
- Holders, for spring plungers

Drawing

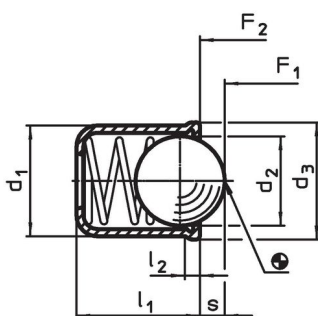

picture 1

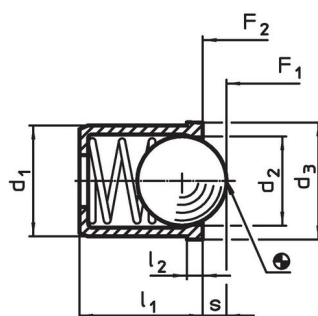

picture 2

Order information

Dimensions					Stroke s [mm]	Spring load ¹⁾		max. [°C]	Location hole H7 [mm]	[g]	Art. No.
d ₁ +0.1	d ₂	d ₃	l ₁	l ₂		F ₁ ~ [N]	F ₂ ~ [N]				
body and ball from stainless steel, light spring load – picture 1											
8	6.5	8.5	9	1.1	2.4	4	9	250	8	2	22080.1008

¹⁾ statistical average value

Application example



Compliance

RoHS compliant

Compliant according to Directive 2011/65/EU and Directive 2015/863.

Does not contain SVHC substances

No SVHC substances with more than 0.1% w/w contained - SVHC list [REACH] as of 27.06.2024.

Does not contain Proposition 65 substances

No Proposition 65 substances included.

<https://www.P65Warnings.ca.gov/>

Free from Conflict Minerals

This product does not contain any substances designated as "conflict minerals" such as tantalum, tin, gold or tungsten from the Democratic Republic of Congo or adjacent countries.