

## Spring Plungers · with collar and ball, front slot

22075.0808



### Product Description

Spring plungers can be used for locating or for applying pressure, as a detent or for ejection. This spring plunger is characterised by the collar with front slot. This makes it suitable for applications that require a flat surface when screwed in.

### Material

#### Body

- Thermoplastic POM, blue

#### Ball

- Thermoplastic POM, white

#### Spring

- Stainless steel

### More information

#### Notes

Customized design on request.

Spring plungers are specially tested for spring range and forces.

#### References

Thread lock on request, please refer to appendix - Technical Data -  
Calculation of indexing resistance, please refer to appendix - Technical Data -

#### Further products

- Spring Plungers, smooth, with collar and ball
- Locators, with bore hole, for spring plungers
- Locators, smooth, for spring plungers

### Drawing

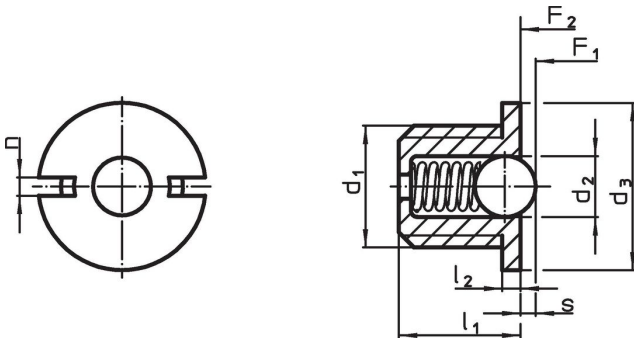

### Order information

Dimensions						Stroke s +0.1 -0.1 [mm]	Spring load <sup>1)</sup>		Temperature		Weight [g]	Art. No.
d <sub>1</sub>	l <sub>1</sub>	d <sub>2</sub>	d <sub>3</sub> -0.1	l <sub>2</sub> -0.1	n		F <sub>1</sub> ~	F <sub>2</sub> ~	min.	max.		
[mm]						[mm]	[N]		[°C]		[g]	
body and ball from thermoplastic, standard spring load												
M8	7	5	10	1.5	1.5	1.5	5.7	10.2	-30	50	0.9	22075.0808

<sup>1)</sup> statistical average value

Accessories

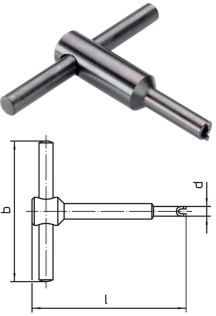
	Dimensions				[g]	Art. No.
	d <sub>1</sub>	b	d	l		
[mm]						
assembly tool						
	M 8	60	9.7	60	47	22075.0908

Application example

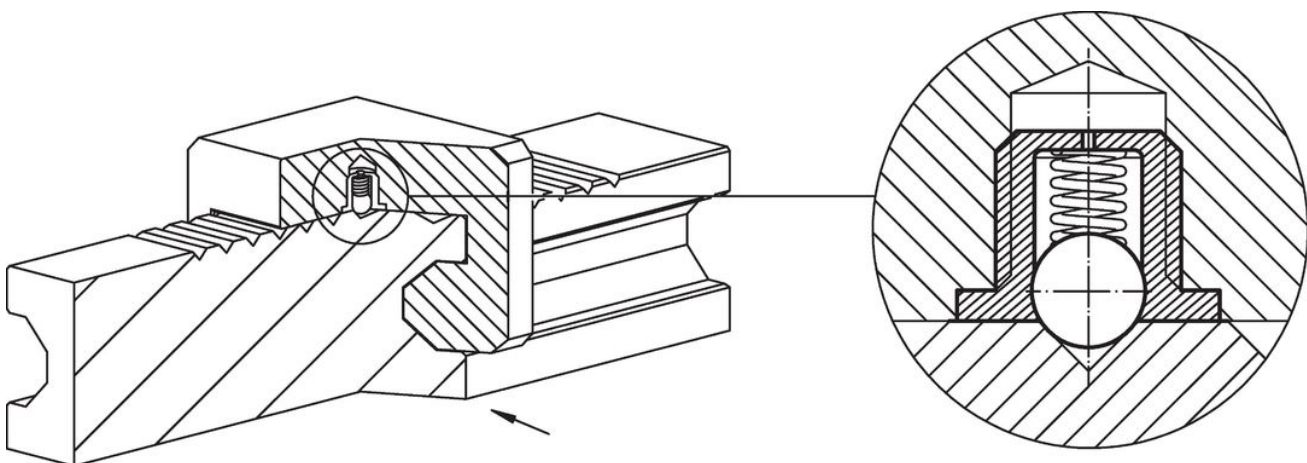
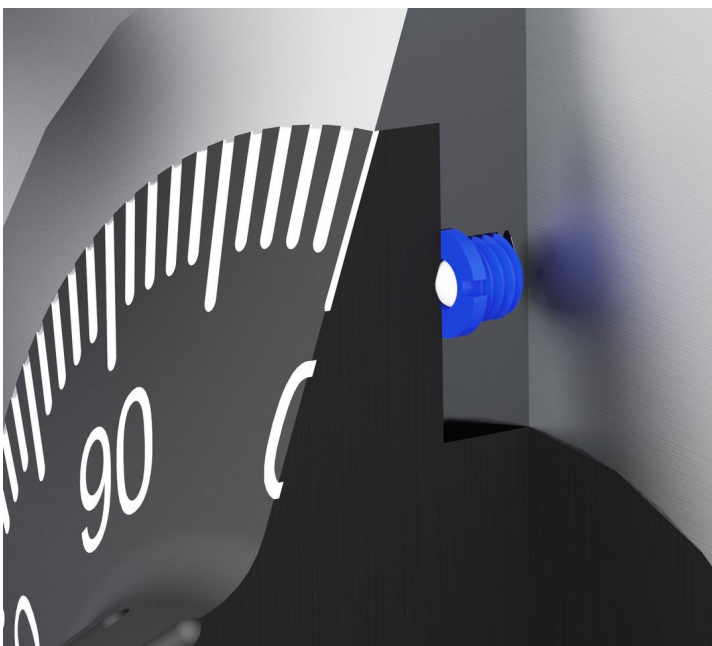

## Compliance

### RoHS compliant

Compliant according to Directive 2011/65/EU and Directive 2015/863.

### Does not contain SVHC substances

No SVHC substances with more than 0.1% w/w contained - SVHC list [REACH] as of 27.06.2024.

### Does not contain Proposition 65 substances

No Proposition 65 substances included.

<https://www.P65Warnings.ca.gov/>

### Free from Conflict Minerals

This product does not contain any substances designated as "conflict minerals" such as tantalum, tin, gold or tungsten from the Democratic Republic of Congo or adjacent countries.