

Spring Plungers · with moveable ceramic ball and slot, stainless steel A4

22051.0506



Product Description

Spring plungers can be used for locating or for applying pressure, as a detent or for ejection. The bearing of the ball allows it to unroll, which minimises wear on the counterpart. This also results in a positive locking behaviour depending on the counterpart.

Another advantage of the moveable ceramic ball is the electric insulation.

Characteristics of the ceramic ball:

- Highly impact-resistant
- Abrasion resistant
- Antimagnetic
- Electrically isolating

The stainless steel A4 version ensures maximum corrosion resistance.

Material

Body

- Stainless steel A4

Bearing

- plastic

Ball

- Ceramic

Spring

- Stainless steel

Characteristic

Standard spring load: no marking

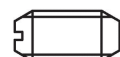

Standard spring load



Heavy spring load

More information

Notes

Special types on request.

Spring plungers are specially tested for spring range and forces.

References

Thread lock on request, please refer to appendix - Technical Data -
Calculation of indexing resistance, please refer to appendix - Technical Data -

Further products

- Spring Plungers, with ceramic ball and slot, stainless steel A4
- Locators, with bore hole, for spring plungers
- Locators, smooth, for spring plungers
- Holders, for spring plungers

Drawing

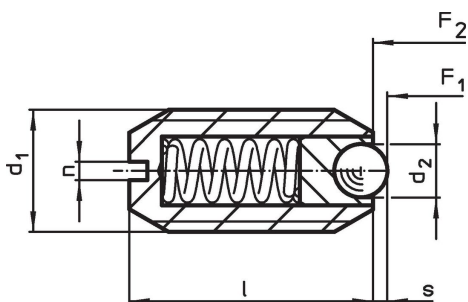

Order information

Dimensions				Stroke s [mm]	Spring load ¹⁾		min. max. [°C]	[g]	Art. No.	
d ₁	d ₂	l	n		F ₁	F ₂				
[mm]					[N]					
Standard spring load										
M6	2.5	14	1	0.7	6.3	10	-30	90	1.5	22051.0506

¹⁾ statistical average value

Application example



Compliance

RoHS compliant

Compliant according to Directive 2011/65/EU and Directive 2015/863.

Does not contain SVHC substances

No SVHC substances with more than 0.1% w/w contained - SVHC list [REACH] as of 23.01.2024.

Does not contain Proposition 65 substances

No Proposition 65 substances included.

<https://www.P65Warnings.ca.gov/>

Free from Conflict Minerals

This product does not contain any substances designated as "conflict minerals" such as tantalum, tin, gold or tungsten from the Democratic Republic of Congo or adjacent countries.