

Clamping Angles · welded, semi-finished

1910.160



Product Description

Material

- Steel, welded

More information

Notes

Special plates on request.

Drawing

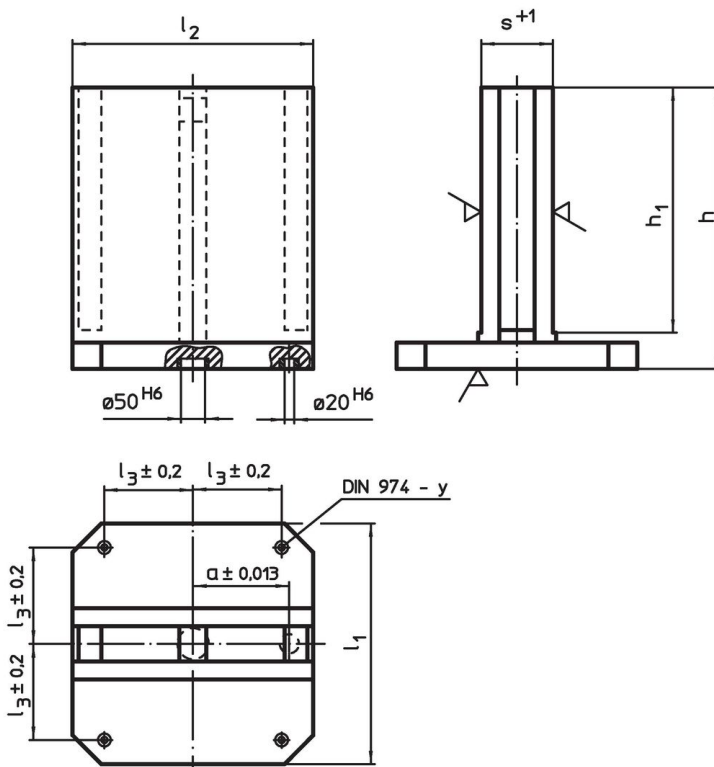

Order information

			Dimensions				y	For screws		Art. No.
l ₁	l ₂	l ₃ ±0.2	h	h ₁	s +1	a ±0.013	[mm]	[mm]	[kg]	
			[mm]							
630	630	200	725	660	181	200	16	M16	409	1910.160

Application example



Compliance

RoHS compliant

Contains lead - compliant according to exceptions 6a / 6b / 6c.

Contains SVHC substances >0,1% w/w

Contains lead - SVHC list [REACH] as of 23.01.2024.

Contains Proposition 65 substances



Lead can cause cancer and reproductive harm from exposure
<https://www.P65Warnings.ca.gov/>

Free from Conflict Minerals

This product does not contain any substances designated as "conflict minerals" such as tantalum, tin, gold or tungsten from the Democratic Republic of Congo or adjacent countries.