

Clamping Angles · semi-finished
1906.410



Product Description

Material

- Grey cast iron GG

More information

Notes

Special plates on request.

Further products

- Threaded Lifting Pins, self-locking

Drawing

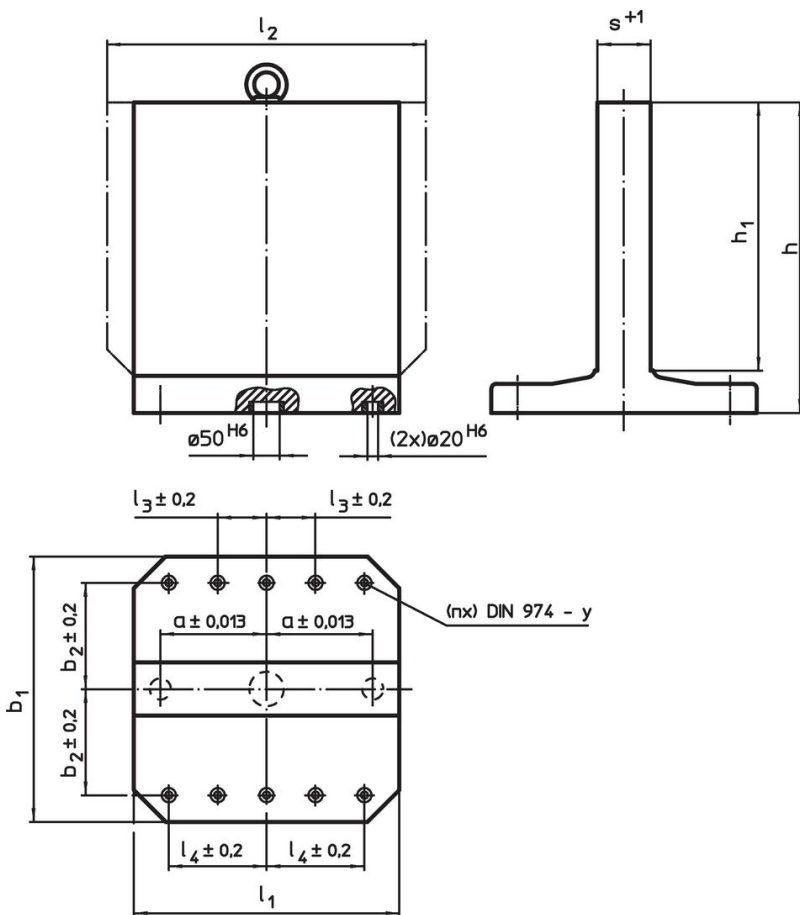

Order information

$b_1 \times l_1$	h_1	h	Dimensions				s	y	For screws	Number of fastening holes n	[kg]	Art. No.
			a	b_2	l_4							
			± 0.013	± 0.2	± 0.2	$+1$	[mm]	[mm]				
Grey cast iron GG												
500 x 500	500	595	200	200	200	101	12	M12	6	284	1906.410	

Application example

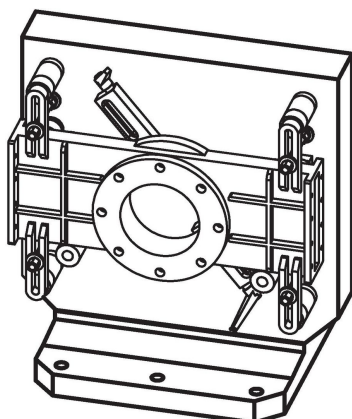

Compliance

RoHS compliant

Contains lead - compliant according to exceptions 6a / 6b / 6c.

Contains SVHC substances >0,1% w/w

Contains lead - SVHC list [REACH] as of 23.01.2024.

Contains Proposition 65 substances



Lead can cause cancer and reproductive harm from exposure
<https://www.P65Warnings.ca.gov/>

Free from Conflict Minerals

This product does not contain any substances designated as "conflict minerals" such as tantalum, tin, gold or tungsten from the Democratic Republic of Congo or adjacent countries.