

Charnières • allongé des deux côtés

25165.0205



Description produit

The different versions cover many applications that require a low load.

These metal hinges are characterised by their simple design and the different versions:

- without bores
- with bores
- with bores for countersunk screws

The version without bores can be assembled by welding or by inserting a specific drilling pattern.

Matières

Corps

- inox 1.4301

Axe

- inox 1.4301

Plan

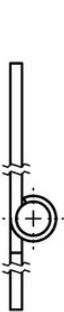
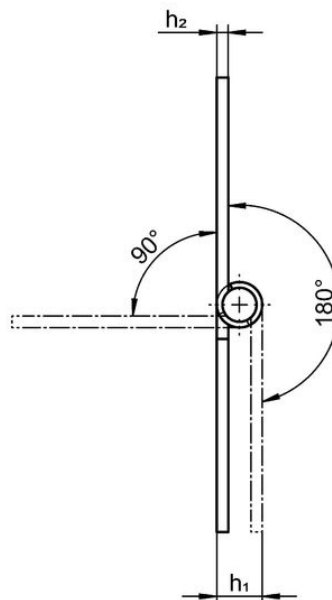
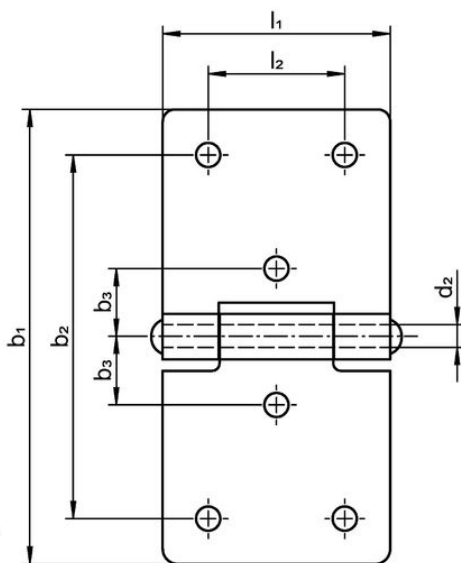

croquis 1

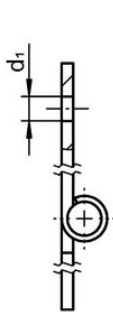

croquis 2

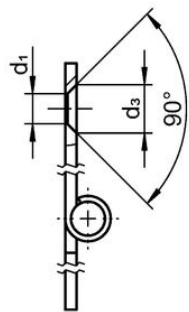

croquis 3

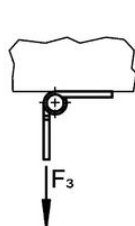
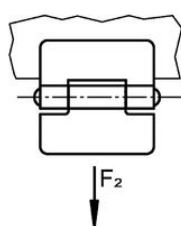
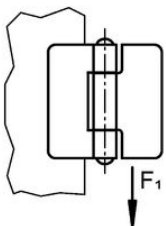

Informations détaillées

b ₁	l ₁	b ₂	b ₃	Dimensions						Force de retenue				Référence article
				d ₁	d ₂	d ₃	h ₁ ~	h ₂	l ₂	F ₁ ~	F ₂ ~	F ₃ ~		
[mm]										[N]			[g]	
avec lisses pour vis à tête fraisée – croquis 3, inox														
100	50	80	15	5	6	8,3	10	2	30	1200	1600	700	98	25165.0205

Conformité

Conforme à la directive RoHS

Conforme à la directive 2011/65/CE et à la directive 2015/863.

Ne contient pas de substances SVHC

Pas de substances SVHC avec une teneur supérieure à 0,1% m/m – Liste SVHC [REACH] au 23.01.2024.

Ne contient pas de substances de la Proposition 65

Aucune des substances de la Proposition 65 présente.

<https://www.P65Warnings.ca.gov/>

Ne contient pas de minerais de la guerre

Ce produit ne contient pas de substances classées comme "minerais de la guerre" telles que le tantale, l'étain, l'or ou le wolfram provenant de République démocratique du Congo ou de pays frontaliers.