

Rubber Endstop Buffers · low structure

EH 25150.



Product Description

For elastic, damping, and noise-reducing bearings. They also protect the surfaces. The rubber endstop buffers can also be used as spacers and foot ends. Hardness is 70 ±5° Shore A.

Material

Support washer

- Steel, zinc-plated by galvanization, passivated

Body

- NBR

Drawing



picture 1



picture 2

Order information

Dimensions						Spring rate R	Load capacity max.	Spring range	Temperature		Weight	Art. No.
d ₁	h	d ₂ +0.5	d ₃ +0.5	s ₁	s ₂	[N/mm]	[N]	[mm]	min.	max.	[g]	
[mm]									[°C]			
with through-bore – picture 1												
19	3	4	7.5	1.5	1.1	282	480	1.70	-30	120	2.8	25150.1119
19	7	4	7.5	1.5	1.1	213	373	1.75	-30	120	3.8	25150.1120
19	14	4	7.5	1.5	1.1	68	240	3.50	-30	120	5.6	25150.1121
25	3	4	7.5	1.5	1.1	1870	1870	1.00	-30	120	5.4	25150.1125
25	8	4	7.5	1.5	1.1	349	698	2.00	-30	120	8.0	25150.1126
25	16	4	7.5	1.5	1.1	135	540	4.00	-30	120	12.0	25150.1127
32	4	5	9.0	2.0	1.1	1680	1680	1.00	-30	120	12.0	25150.1132
32	9	5	9.0	2.0	1.1	548	1233	2.25	-30	120	16.0	25150.1133
32	18	5	9.0	2.0	1.1	212	850	4.00	-30	120	23.0	25150.1134
38	4	5	9.0	2.0	1.1	1500	1500	1.00	-30	120	17.0	25150.1138
38	10	5	9.0	2.0	1.1	704	1760	2.50	-30	120	25.0	25150.1139
38	20	5	9.0	2.0	1.1	230	920	4.00	-30	120	37.0	25150.1140
50	5	6	11.0	2.5	1.1	3600	3600	1.00	-30	120	39.0	25150.1150
50	11	6	11.0	2.5	1.1	1223	3670	3.00	-30	120	51.0	25150.1151
50	22	6	11.0	2.5	1.1	500	2500	5.00	-30	120	74.0	25150.1152
64	5	6	11.0	2.5	1.1	1460	1460	1.00	-30	120	66.0	25150.1164
64	13	6	11.0	2.5	1.1	2016	6050	3.00	-30	120	95.0	25150.1165
64	26	6	11.0	2.5	1.1	616	3700	6.00	-30	120	141.0	25150.1166
with through-bore and adhesive pad – picture 2												
19	3	4	7.5	1.5	1.1	282	480	1.70	-30	120	2.9	25150.1219
19	7	4	7.5	1.5	1.1	213	373	1.75	-30	120	5.1	25150.1220
19	14	4	7.5	1.5	1.1	68	240	3.50	-30	120	6.9	25150.1221
25	3	4	7.5	1.5	1.1	1870	1870	1.00	-30	120	6.9	25150.1225
25	8	4	7.5	1.5	1.1	349	698	2.00	-30	120	9.3	25150.1226
25	16	4	7.5	1.5	1.1	135	540	4.00	-30	120	13.0	25150.1227
32	4	5	9.0	2.0	1.1	1680	1680	1.00	-30	120	13.0	25150.1232

d ₁	h	Dimensions				s ₁	s ₂	Spring rate R [N/mm]	Load capacity max. [N]	Spring range [mm]	Temperature		Weight [g]	Art. No.
		d ₂ +0.5	d ₃ +0.5	[mm]							min.	max.		
32	9	5	9.0	2.0	1.1	548	1233	2.25	-30	120	18.0	25150.1233		
32	18	5	9.0	2.0	1.1	212	850	4.00	-30	120	25.0	25150.1234		
38	4	5	9.0	2.0	1.1	1500	1500	1.00	-30	120	19.0	25150.1238		
38	10	5	9.0	2.0	1.1	704	1760	2.50	-30	120	26.0	25150.1239		
38	20	5	9.0	2.0	1.1	230	920	4.00	-30	120	38.0	25150.1240		
50	5	6	11.0	2.5	1.1	3600	3600	1.00	-30	120	41.0	25150.1250		
50	11	6	11.0	2.5	1.1	1223	3670	3.00	-30	120	54.0	25150.1251		
50	22	6	11.0	2.5	1.1	500	2500	5.00	-30	120	77.0	25150.1252		
64	5	6	11.0	2.5	1.1	1460	1460	1.00	-30	120	71.0	25150.1264		
64	13	6	11.0	2.5	1.1	2016	6050	3.00	-30	120	99.0	25150.1265		
64	26	6	11.0	2.5	1.1	616	3700	6.00	-30	120	149.0	25150.1266		

Application example

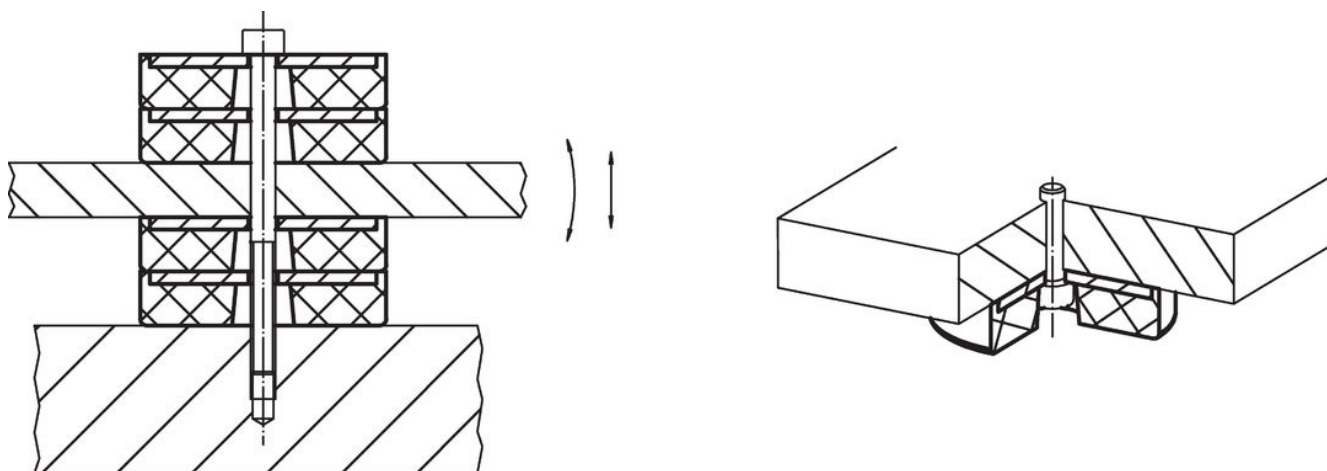

Compliance

RoHS compliant

Contains lead - compliant according to exceptions 6a / 6b / 6c.

Contains SVHC substances >0,1% w/w

Contains lead - SVHC list [REACH] as of 23.01.2024.

Contains Proposition 65 substances



Lead can cause cancer and reproductive harm from exposure
<https://www.P65Warnings.ca.gov/>

Free from Conflict Minerals

This product does not contain any substances designated as "conflict minerals" such as tantalum, tin, gold or tungsten from the Democratic Republic of Congo or adjacent countries.