

Star Grip Screws • Stainless steel

EH 24690.



Product Description

Material

Handle

- Stainless steel 1.4301, dull blasted

Screw

- Stainless steel 1.4301

More information

Notes

Grip: Sheet-iron drawn. **Hub:** Butt-welded

Drawing

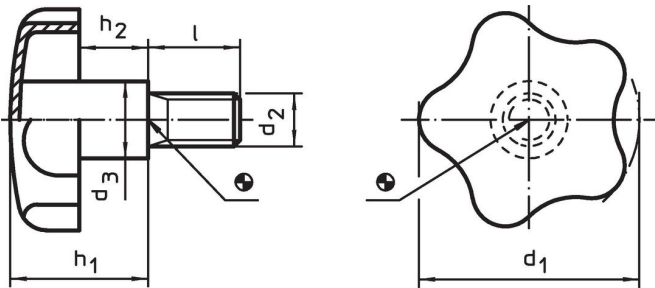

Order information

d ₁	d ₂	l	Dimensions			[g]	Art. No.
			d ₃	h ₁ ~	h ₂ ~		
			[mm]				
40	M 8	20	14	24.0	12.0	50	24690.0140
40	M 8	30	14	24.0	12.0	55	24690.0142
40	M 8	40	14	24.0	12.0	57	24690.0144
50	M10	20	18	30.0	16.5	95	24690.0150
50	M10	30	18	30.0	16.5	97	24690.0152
50	M10	40	18	30.0	16.5	102	24690.0154
60	M12	30	20	37.5	20.0	155	24690.0160
60	M12	40	20	37.5	20.0	162	24690.0162
60	M12	50	20	37.5	20.0	169	24690.0164

Application example

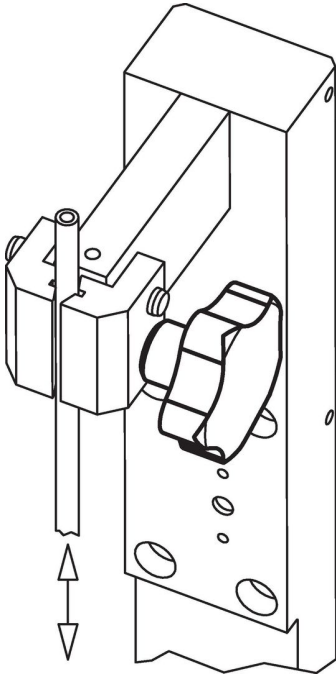

Compliance

RoHS compliant

Compliant according to Directive 2011/65/EU and Directive 2015/863.

Does not contain SVHC substances

No SVHC substances with more than 0.1% w/w contained - SVHC list [REACH] as of 27.06.2024.

Does not contain Proposition 65 substances

No Proposition 65 substances included.
<https://www.P65Warnings.ca.gov/>

Free from Conflict Minerals

This product does not contain any substances designated as "conflict minerals" such as tantalum, tin, gold or tungsten from the Democratic Republic of Congo or adjacent countries.