

Rotating Machine Handles • DIN 98

EH 24460.



Product Description

Material

- Steel, turned, zinc-plated by galvanization, passivated

Drawing

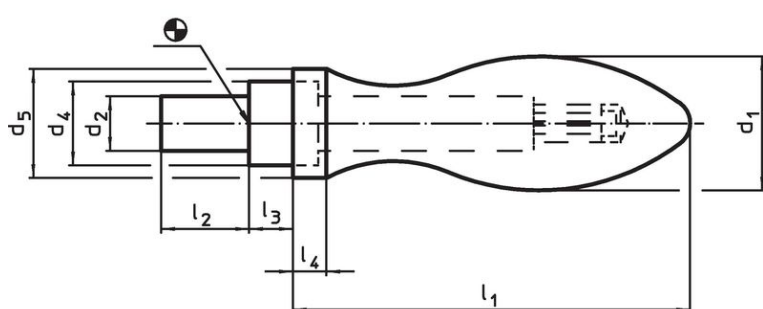

picture 1

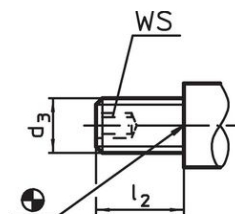

picture 2

Order information

d ₁	d ₂ h8	d ₃	d ₄ h13	Dimensions					WS [mm]	[g]	Art. No.
				d ₅ [mm]	l ₁ ~	l ₂	l ₃	l ₄			
with smooth lug, form D – picture 1											
16	7	–	10	14	49	11	5.5	5.0	–	69	24460.0016
20	8	–	13	18	61	13	6.0	6.0	–	109	24460.0020
25	10	–	16	21	75	14	8.0	6.5	–	200	24460.0025
32	13	–	20	26	95	21	10.5	8.0	–	395	24460.0032
36	16	–	22	29	106	26	11.0	9.0	–	569	24460.0036
with male thread lug, form E – picture 2											
16	–	M 6	10	14	49	11	5.5	5.0	3	51	24460.0116
20	–	M 8	13	18	61	13	6.0	6.0	4	105	24460.0120
25	–	M10	16	21	75	14	8.0	6.5	5	190	24460.0125
32	–	M12	20	26	95	21	10.5	8.0	6	387	24460.0132
36	–	M16	22	29	106	26	11.0	9.0	8	566	24460.0136

Application example

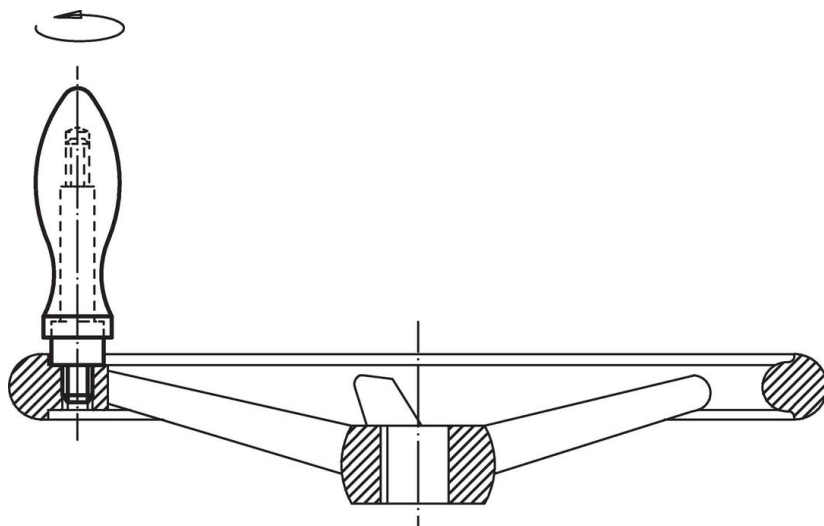

Compliance

RoHS compliant

Contains lead - compliant according to exceptions 6a / 6b / 6c.

Contains SVHC substances >0,1% w/w

Contains lead - SVHC list [REACH] as of 23.01.2024.

Contains Proposition 65 substances



Lead can cause cancer and reproductive harm from exposure
<https://www.P65Warnings.ca.gov/>

Free from Conflict Minerals

This product does not contain any substances designated as "conflict minerals" such as tantalum, tin, gold or tungsten from the Democratic Republic of Congo or adjacent countries.